

# VITRAFORM





Retail Price List / January 1, 2022



<b>1.0 Standard Basin</b> Undermount and Drop-in 	Round or Oval with Overflow	5
	Round or Oval without Overflow	6
	GILDED Round or Oval with Overflow	7
	GILDED Round or Oval without Overflow	8
	Rectangular Basin with Overflow	9
	Rectangular Basin without Overflow	10
	GILDED Rectangular Basin with Overflow	11
GILDED Rectangular Basin without Overflow	12	

<b>2.0 Rimless Undermount</b> 	Round with Overflow	14
	Round without Overflow	15
	Oval with Overflow	16
	Oval without Overflow	17
	GILDED Round or Oval with Overflow	18
	GILDED Round or Oval without Overflow	19

<b>3.0 Freestanding Basin</b> 	Round	21
	Oval	22
	GILDED Round	23
	GILDED Oval	24
	Rectangular <b>NEW PRODUCT</b>	25
GILDED Rectangular <b>NEW PRODUCT</b>	26	

<b>4.0 Countersink</b> 	Round or Oval with Overflow	28
	Round or Oval without Overflow	29
	Rectangular with Overflow	30
	Rectangular without Overflow	31
	Countersink Console	33-34
	Countersink Wash Stand	35-36

<b>5.0 Countertop</b>		38
-----------------------	---	----

<b>6.0 Pedestal</b> 	Arabesque and Battuto	40
	Cono	41
	Coppa	42
	Cubetto	43
	Glass Rod	44
	Pullman	45-46

<b>7.0 Wood Vanity</b> 	GN2 Vanity	48
	GN Vanity	49
	Oval Vanity	50
	T Vanity	51

<b>8.0 Mirror</b>		Mirrors	52
-------------------	---	---------	----

<b>B.0 Hardware</b> 	Drains	53
	Mounting System Hardware	54-58

<b>A.0 Colors &amp; Finishes</b>	3
----------------------------------	---

<b>C.0 Ordering Information</b>	59
---------------------------------	----















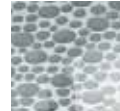

## Vitraform Colors and Finishes

### Glass Colors









	Polished	Frosted	White Lami	Satin Etched	Mirror	Chalk	Pearl
Clear							
Starphire®							
Cristal					NA		
Cristal Antique		NA	NA	NA		NA	NA
Solex®							
Azurlite®							
Blue							
Cobalt			NA			NA	
Grey							
Black			NA		NA	NA	NA
Bronze							
Peach							

Glass colors offered only with the finishes shown. Contact Factory for custom options.  
Starphire, Azurlite and Solex are registered trademarks of PPG Industries, Inc.







### Engraved Designs

					
Empire	Floral	Victorian	Deco	Tulip	Tulip Border
					
Traditional	Roman	Moderne	1960	1930	Fine Lines
					
Bamboo	Battuto	Confetti	Zebra	Tebori	Arabesque
					
Palmier	Entre Deux	Eolienne	Emboss		

### Gilded Finishes

					
Cubiste	Fragment	Graphique	Vapeur	Desir	Envie
					
Matte	Lustre				

### Wood Finishes

						
Anigre	Ebony	Sapele	Sycamore	Teak	Walnut	Wenge

Standard Basin



Rectangular Standard Basin in Crystal Antique with Rose Gold Matte Finish.



Rectangular Standard Basin in Starphire Chalk Finish.  
Shown with matching round Mirror.

Standard Basin / Round or Oval With Overflow Retail Price List

To order, select an option in each of columns A–E. Order overflow and Drain separately. Include Item No. and Price. See Example at bottom of page.

A Select Type of Basin			B Glass Color		C Glass Finish			D Overflow		E With Engraving Add			
Price based on Color Groups.			All Vitraform glass has color at the edge. None are devoid of color.					Overflow required but NOT included. Order separately. See Overflow column at right		See NOTE in column C for available finishes on engraved basins.			
Color Group 1 Pricing			Color Group 1							Round	Oval		
Item	Description	Price	Item	Color	Item	Finish	Add	Item		Item	Engraving	Add	Add
100	Round Undermount 17.5" Dia	\$ 955	C	Clear	P	Polished	\$ 00	F	Overflow	00	None	\$ 00	\$ 00
150	Oval Undermount 20.75 x 16.25"	\$ 955	S	Starphire®	F	Frosted <sup>1</sup>	\$ 50			11	Empire	\$1,500	\$1,705
101	Round Drop-In <sup>1</sup> 17.5" Dia	\$ 1,100	Z	Bronze	O	White Lami <sup>3,4</sup>	\$ 50			12	Floral	\$ 1,175	\$1,385
151	Oval Drop-In <sup>1</sup> 20.75 x 16.25"	\$ 1,100	G	Grey	S	Satin Etched <sup>2</sup>	\$ 135			13	Victorian	\$1,500	\$1,705
See NOTE below about color for Drop-in use.			K	Black	M	Mirror <sup>3</sup>	\$ 365			14	Deco	\$1,500	\$1,705
Color Group 2 Pricing			Color Group 2		H	Chalk <sup>3,4</sup>	\$ 495			15	Tulip	\$1,500	\$1,705
Item	Description	Price	Item	Color	E	Pearl <sup>3</sup>	\$ 180			16	Tulip Border	\$1,385	\$1,595
100	Round Undermount 17.5" Dia	\$ 1,185	P	Peach	<sup>1</sup> Frosted finish on bottom surface only. <sup>2</sup> Satin Etched finish on inside and outside surface. <sup>3</sup> White Lami, Mirror, Chalk or Pearl Finish not available on Black. <sup>4</sup> White Lami or Chalk Finish not available on Cobalt. NOTE: FINISHES FOR ENGRAVINGS Frosted finish recommended for Undermount basins with engraving. For Polished finish contact factory. White Lami, Satin Etched, Mirror, Pearl or Chalk finishes cannot be engraved.								
150	Oval Undermount 20.75 x 16.25"	\$ 1,185	A	Azurlite®						17	Traditional	\$1,385	\$1,595
101	Round Drop-In <sup>1</sup> 17.5" Dia	\$ 1,330	X	Solex®						18	Roman	\$1,285	\$1,495
151	Oval Drop-In <sup>1</sup> 20.75 x 16.25"	\$ 1,330								20	Moderne	\$1,500	N/A
See NOTE below about color for Drop-in use.										25	1960		
Color Group 3 Pricing			Color Group 3							26	1930		
Item	Description	Price	Item	Color						28	Fine Lines		
100	Round Undermount 17.5" Dia	\$ 1,615	T	Cobalt						29	Bamboo		
150	Oval Undermount 20.75 x 16.25"	\$ 1,615	B	Blue						30	Battuto		These engraved designs are not available on Standard Basins. Please refer to price pages 14-17 for Rimless Undermounts to be used with these engraved patterns.
101	Round Drop-In <sup>1</sup> 17.5" Dia	\$ 1,785	L	Cristal						31	Confetti		
151	Oval Drop-In <sup>1</sup> 20.75 x 16.25"	\$ 1,785	Q	Cristal Antiq						33	Zebra		
See NOTE below about color for Drop-in use.										34	Tebori		
1 Items 101 and 151 are offered with a gasket for Drop-in installation on Clear, Starphire and Cristal polished glass. NOTE: For Bronze, Grey, Black, Cobalt and Blue polished glass or any color with White Lami, Mirror, Satin Etched, Chalk or Pearl finishes for drop-in installation, order item 100 or 150 for drop-in installations.										36	Arabesque		
										38	Palmier		
										40	Entre Deux		
										43	Eolienne vert.		
										44	Eolienne hor.		



Overflow					
Required. Order separately. See <b>Order Example</b> at lower left of page.					
See Metal Finish Codes below.					
Item	Price	1	2	3	4
<b>Overflow</b>					
911.XX Round	\$ 255	\$ 255	\$ 260	\$ 285	
916.XX Oval	\$ 255	\$ 255	\$ 260	\$ 285	
Drain Optional. Order separately.					
See Metal Finish Codes below.					
Item	Price	1	2	3	4
<b>Grid Strainer Set</b>					
810.XX w US PTrap	\$ 330	\$ 575	\$ 750	\$ 820	
810.XX.S w Siphon	\$ 455	\$ 670	\$ 855	\$ 920	
<b>Dome Open Set</b>					
860.XX w US PTrap	\$ 330	\$ 575	\$ 750	\$ 820	
860.XX.S w Siphon	\$ 455	\$ 670	\$ 855	\$ 920	
<b>Dome Pop-up Set</b>					
862.XX w US PTrap	\$ 330	\$ 575	\$ 750	\$ 820	
862.XX.S w Siphon	\$ 455	\$ 670	\$ 855	\$ 920	
Metal Finish Codes					
1	2	3	4		
10 Pol. Chrome	12 Pol. Nickel 20 Sat. Chrome 22 Sat. Nickel	15 ORB 16 Pol. Brass*	13 Pol. Gold* 23 Sat. Gold*		
* Brass and Gold Finishes are PVD.					

Order Example	A	B	C	D	E	Engraving Color Upcharge	Select an option in each column A-E including Overflow (required) and Drain (optional).
Basin Item No.	100	P	F	F	14	by Glass Color + \$ 110	Basin Price \$ 2,845
Basin Price	\$ 1,185	-	\$ 50	-	\$ 1,500		
	Round Undermount	Peach	Frosted	Deco Engraving	Overflow		
Overflow Item No.	911	10	Round Overflow / Pol. Chrome Metal Finish (10)			Overflow Price	\$ + 255
Drain Item No.	860	10	Dome Open Set / Overflow / US PTrap / Pol. Chrome Metal Finish (10)			Drain Price	\$ + 330
						<b>Total Price</b>	<b>\$ 3,430</b>

Engraving Color Upcharge	
Upcharges for glass color to be added into price. Does not affect item number.	
Glass Color	Add
Clear, Cristal, Cristal Antiq, Starphire	\$ 00
Bronze, Grey, Peach, Azurlite, Solex, Blue,	\$ 110
NOTE: Engraving on Black or Cobalt are not appropriate for Undermount or Drop-in installations. Request assistance.	



Standard Basin / Round or Oval Without Overflow To order, select an option in each of columns A–E. Order overflow and Drain separately. Include Item No. and Price. See Example at bottom of page. Retail Price List

A Select Type of Basin		
Price based on Color Groups.		
Color Group 1 Pricing		
Item	Description	Price
100	Round Undermount 17.5" Dia	\$ 955
150	Oval Undermount 20.75 x 16.25"	\$ 955
101	Round Drop-In <sup>1</sup> 17.5" Dia	\$ 1,100
151	Oval Drop-In <sup>1</sup> 20.75 x 16.25"	\$ 1,100
See NOTE below about color for Drop-in use.		
Color Group 2 Pricing		
Item	Description	Price
100	Round Undermount 17.5" Dia	\$ 1,185
150	Oval Undermount 20.75 x 16.25"	\$ 1,185
101	Round Drop-In <sup>1</sup> 17.5" Dia	\$ 1,330
151	Oval Drop-In <sup>1</sup> 20.75 x 16.25"	\$ 1,330
See NOTE below about color for Drop-in use.		
Color Group 3 Pricing		
Item	Description	Price
100	Round Undermount 17.5" Dia	\$ 1,615
150	Oval Undermount 20.75 x 16.25"	\$ 1,615
101	Round Drop-In <sup>1</sup> 17.5" Dia	\$ 1,785
151	Oval Drop-In <sup>1</sup> 20.75 x 16.25"	\$ 1,785
See NOTE below about color for Drop-in use.		
1 Items 101 and 151 are offered with a gasket for Drop-in installation on Clear, Starphire and Cristal polished glass. NOTE: For Bronze, Grey, Black, Cobalt and Blue polished glass or any color with White Lami, Mirror, Satin Etched, Chalk or Pearl finishes for drop-in installation, order item 100 or 150 for drop-in installations.		

B Glass Color	
All Vitraform glass has color at the edge. None are devoid of color.	
Color Group 1	
Item	Color
C	Clear
S	Starphire®
Z	Bronze
G	Grey
K	Black
Color Group 2	
Item	Color
P	Peach
A	Azurlite®
X	Solex®
Color Group 3	
Item	Color
T	Cobalt
B	Blue
L	Cristal
Q	Cristal Antiq
For White color specify Starphire glass in Color Group 1 with White Lami Finish in Column C.	

C Glass Finish		
Item	Finish	Add
P	Polished	\$ 00
F	Frosted <sup>1</sup>	\$ 50
O	White Lami <sup>3,4</sup>	\$ 50
S	Satin Etched <sup>2</sup>	\$ 135
M	Mirror <sup>3</sup>	\$ 365
H	Chalk <sup>3,4</sup>	\$ 180
E	Pearl <sup>3</sup>	\$ 495
1 Frosted finish on bottom surface only. 2 Satin Etched finish on inside and outside surface. 3 White Lami, Mirror, Chalk or Pearl Finish not available on Black. 4 White Lami or Chalk Finish not available on Cobalt. NOTE: FINISHES FOR ENGRAVINGS Frosted finish recommended for Undermount basins with engraving. For Polished finish contact factory. White Lami, Satin Etched, Mirror, Pearl or Chalk finishes cannot be engraved.		

D Drain Collar	
Drain Collar is required but is NOT included. Order separately. See Drain Collar column at right.	
Item	
C	Drain Collar

E With Engraving Add			
See NOTE in column C for available finishes on engraved basins.			
		Round	Oval
Item	Engraving	Add	Add
00	None	\$ 00	\$ 00
11	Empire	\$ 1,500	\$ 1,705
12	Floral	\$ 1,175	\$ 1,385
13	Victorian	\$ 1,500	\$ 1,705
14	Deco	\$ 1,500	\$ 1,705
15	Tulip	\$ 1,500	\$ 1,705
16	Tulip Border	\$ 1,385	\$ 1,595
17	Traditional	\$ 1,385	\$ 1,595
18	Roman	\$ 1,285	\$ 1,495
20	Moderne	\$ 1,500	N/A
25	1960		
26	1930		
28	Fine Lines		
29	Bamboo		
30	Battuto	These engraved designs are not available on Standard Basins. Please refer to price pages 14-17 for Rimless Undermounts to be used with these engraved patterns.	
31	Confetti		
33	Zebra		
34	Tebori		
36	Arabesque		
38	Palmier		
40	Entre Deux		
43	Eolienne vert.		
44	Eolienne hor.		

Drain Collar				
Required. Order separately. See Order Example at lower left of page.				
See Metal Finish Codes below.				
Item	Price			
Drain Collar	1	2	3	4
900.XX	\$ 50	\$ 50	\$ 55	\$ 60
Drain Optional. Order separately.				
See Metal Finish Codes below.				
Item	Price			
Grid Strainer Set	1	2	3	4
811.XX w US PTrap	\$ 330	\$ 575	\$ 750	\$ 820
811.XX.S w Siphon	\$ 455	\$ 670	\$ 855	\$ 920
Dome Open Set				
861.XX w US PTrap	\$ 330	\$ 575	\$ 750	\$ 820
861.XX.S w Siphon	\$ 455	\$ 670	\$ 855	\$ 920
Dome Pop-up Set				
863.XX w US PTrap	\$ 330	\$ 575	\$ 750	\$ 820
863.XX.S w Siphon	\$ 455	\$ 670	\$ 855	\$ 920
Metal Finish Codes				
1	2	3	4	
10 Pol. Chrome	12 Pol. Nickel 20 Sat. Chrome 22 Sat. Nickel	15 ORB 16 Pol. Brass*	13 Pol. Gold* 23 Sat. Gold*	
* Brass and Gold Finishes are PVD.				



Order Example	A	B	C	D	E	Engraving Color Upcharge	Select an option in each column A-E including Drain Collar (required) and Drain (optional).
Basin Item No.	151	L	F	C	11		
Basin Price	\$ 1,785	-	\$ 50	-	\$ 1,705	by Glass Color + \$ 00	Basin Price \$ 3,540
Oval Drop-In Basin      Frosted      Empire Engraving Cristal      Drain Collar							
Drain Collar Item No.	900	10	Drain Collar / Pol. Chrome Metal Finish (10)		Drain Collar Price	\$ + 50	
Drain Item No.	861	10S	Dome Open Set / Siphon / Pol. Chrome Metal Finish (10)		Drain Price	\$ + 455	
						Total Price	\$ 4,045

Engraving Color Upcharge	
Upcharges for glass color to be added into price. Does not affect item number.	
Glass Color	Add
Clear, Cristal, Cristal Antiq, Starphire	\$ 00
Bronze, Grey, Peach, Azurlite, Solex, Blue,	\$ 110
NOTE: Engraving on Black or Cobalt are not appropriate for Undermount or Drop-in installations. Request assistance.	

**Standard Basin / Round or Oval With Overflow**

To order, select an option in each of columns A–E. Order Drain separately. Include Item No. and Price. See Example at bottom of page.

Retail Price List

A Select Type of Basin	
Price based on Color Groups.	
Basin Size	
Item	Round and Oval
100	Round Undermount 17.5" Dia
150	Oval Undermount 20.75 x 16.25"
Graphique, Fragment, Cubiste, Matte and Lustre finishes may be installed as drop-in.	

B Glass Color	
All Vitraform glass has color at the edge. None are devoid of color.	
Color Group 1	
Item	Color
K	Black
Black used for Graphique and Fragment patterns.	
Color Group 3	
Item	Color
Q	Cristal Antiq
Cristal Antique used for Vapeur, Cubiste, Matte and Luster Patterns.	

C Glass Finish	
Item	Finish
R	Rose Gold
W	White Gold

D Overflow	
Overflow required but NOT included. Order separately. See Overflow column at right.	
Item	
F	Overflow

E Gilded Finish			
This page is for Gilded Finishes only.			
Color Group 1		Price	Price
Item	Pattern	100	150
GR	Graphique <sup>1</sup>	\$ 3,930	\$ 4,535
FR	Fragment <sup>1</sup>	\$ 2,055	\$ 2,055
<sup>1</sup> These patterns available on Black glass only.			
Color Group 3		Price	Price
Item	Pattern	100	150
VA	Vapeur <sup>2</sup>	\$ 5,685	\$ 5,810
CU	Cubiste <sup>2</sup>	\$ 5,685	\$ 5,810
MA	Matte <sup>2</sup>	\$ 4,660	\$ 4,660
LU	Lustre <sup>2</sup>	\$ 6,170	\$ 6,230
<sup>2</sup> These patterns available on Cristal Antique glass only.			



Overflow				
Required. Order separately. See <b>Order Example</b> at lower left of page.				
See Metal Finish Codes below.				
Item	Price			
Overflow	1	2	3	4
911.XX Round	\$ 255	\$ 255	\$ 260	\$ 285
916.XX Oval	\$ 255	\$ 255	\$ 260	\$ 285
Drain Optional. Order separately.				
See Metal Finish Codes below.				
Item	Price			
Grid Strainer Set	1	2	3	4
810.XX w US PTrap	\$ 330	\$ 575	\$ 750	\$ 820
810.XX.S w Siphon	\$ 455	\$ 670	\$ 855	\$ 920
Dome Open Set				
860.XX w US PTrap	\$ 330	\$ 575	\$ 750	\$ 820
860.XX.S w Siphon	\$ 455	\$ 670	\$ 855	\$ 920
Dome Pop-up Set				
862.XX w US PTrap	\$ 330	\$ 575	\$ 750	\$ 820
862.XX.S w Siphon	\$ 455	\$ 670	\$ 855	\$ 920
Metal Finish Codes				
1	2	3	4	
10 Pol. Chrome	12 Pol. Nickel 20 Sat. Chrome 22 Sat. Nickel	15 ORB 16 Pol. Brass*	13 Pol. Gold* 23 Sat. Gold*	
* Brass and Gold Finishes are PVD.				

Order Example	A	B	C	D	E	Engraving Color Upcharge	Select an option in each column A-E including Overflow (required) and Drain (optional).
Basin Item No.	150	K	W	F	GR	NA	Basin Price \$ 4,535
Basin Price	-	-	-	-	\$ 4,535	NA	Basin Price \$ 4,535
	Oval Undermount	Black	White Gold	Graphique Pattern	Overflow		
Overflow Item No.	916	10	Round Overflow / Pol. Chrome Metal Finish (10)		Overflow Price	\$ + 255	
Drain Item No.	860	10S	Dome Open Set / Siphon / Pol. Chrome Metal Finish (10)		Drain Price	\$ + 455	
					Total Price	\$ 5,245	



**Standard Basin / Round or Oval Without Overflow**

To order, select an option in each of columns A-E. Order Drain separately. Include Item No. and Price. See Example at bottom of page.

Retail Price List

A Select Type of Basin	
Price based on Color Groups.	
Basin Size	
Item	Round and Oval
100	Round Undermount 17.5" Dia
150	Oval Undermount 20.75 x 16.25"
Graphique, Fragment, Cubiste, Matte and Lustre finishes may be installed as drop-in.	

B Glass Color	
All Vitraform glass has color at the edge. None are devoid of color.	
Color Group 1	
Item	Color
K	Black
Black used for Graphique and Fragment patterns.	
Color Group 3	
Item	Color
Q	Cristal Antiq
Cristal Antique used for Vapeur, Cubiste, Matte and Luster Patterns.	

C Glass Finish	
Item	Finish
R	Rose Gold
W	White Gold

D Drain Collar	
Drain Collar is required but is NOT included. Order separately. See Drain Collar column at right.	
Item	
C	Drain Collar

E Gilded Finish			
This page is for Gilded Finishes only.			
Color Group 1		Price	Price
Item	Pattern	100	150
GR	Graphique <sup>1</sup>	\$ 3,930	\$ 4,535
FR	Fragment <sup>1</sup>	\$ 2,055	\$ 2,055
<sup>1</sup> These patterns available on Black glass only.			
Color Group 3		Price	Price
Item	Pattern	100	150
VA	Vapeur <sup>2</sup>	\$ 5,685	\$ 5,810
CU	Cubiste <sup>2</sup>	\$ 5,685	\$ 5,810
MA	Matte <sup>2</sup>	\$ 4,660	\$ 4,660
LU	Lustre <sup>2</sup>	\$ 6,170	\$ 6,230
<sup>2</sup> These patterns available on Cristal Antique glass only.			



Drain Collar				
Required. Order separately. See Order Example at lower left of page.				
See Metal Finish Codes below.				
Item	Price			
Drain Collar	1	2	3	4
900.XX	\$ 50	\$ 50	\$ 55	\$ 60
Drain Optional. Order separately.				
See Metal Finish Codes below.				
Item	Price			
Grid Strainer Set	1	2	3	4
811.XX w US PTrap	\$ 330	\$ 575	\$ 750	\$ 820
811.XX.S w Siphon	\$ 455	\$ 670	\$ 855	\$ 920
Dome Open Set				
861.XX w US PTrap	\$ 330	\$ 575	\$ 750	\$ 820
861.XX.S w Siphon	\$ 455	\$ 670	\$ 855	\$ 920
Dome Pop-up Set				
863.XX w US PTrap	\$ 330	\$ 575	\$ 750	\$ 820
863.XX.S w Siphon	\$ 455	\$ 670	\$ 855	\$ 920
Metal Finish Codes				
1	2	3	4	
10 Pol. Chrome	12 Pol. Nickel 20 Sat. Chrome 22 Sat. Nickel	15 ORB 16 Pol. Brass*	13 Pol. Gold* 23 Sat. Gold*	
* Brass and Gold Finishes are PVD.				

Order Example	A	B	C	D	E	Engraving Color Upcharge	Select an option in each column A-E including Drain Collar (required) and Drain (optional).
Basin Item No.	100	Q	R	C	MA	NA	Basin Price \$ 4,660
Basin Price	-	-	-	-	\$ 4,660	NA	Basin Price \$ 4,660
	Round Drop-in Basin	Cristal Antiq	Rose Gold	Drain Collar	Matte Pattern		
Drain Collar Item No.	900	22	Drain Collar / Satin Nickel Metal Finish (22)		Drain Collar Price	\$ + 50	
Drain Item No.	861	22S	Dome Open Set / Siphon / Satin Nickel Metal Finish (22)		Drain Price	\$ + 670	
					Total Price	\$ 5,380	





## Standard Basin / Rectangular With Overflow

To order, select an option in each of columns A–E. Order overflow and Drain separately. Include Item No. and Price. See Example at bottom of page.

Retail Price List

A Select Type of Basin		
Price based on Color Groups. Mini Rectangular Basin 12.25 x 15.25 in. Small Rectangular Basin 17 x 22 in. Rectangular Basin 18 x 24 in.		
Color Group 1 Pricing		
Item	Description	Price
130	Mini Undermount	\$ 1,100
131	Mini Drop-in <sup>1</sup>	\$ 1,100
140	Small Undermount	\$ 3,060
141	Small Drop-in <sup>1</sup>	\$ 3,060
170	Undermount	\$ 3,060
171	Drop-in <sup>1</sup>	\$ 3,060
* 1 Drop-in color options NOTE below.		
Color Group 2 Pricing		
Item	Description	Price
130	Mini Undermount	\$ 1,330
131	Mini Drop-in <sup>1</sup>	\$ 1,330
140	Small Undermount	\$ 3,195
141	Small Drop-in <sup>1</sup>	\$ 3,195
170	Undermount	\$ 3,195
171	Drop-in <sup>1</sup>	\$ 3,195
* 1 Drop-in color options NOTE below.		
Color Group 3 Pricing		
Item	Description	Price
130	Mini Undermount	\$ 1,785
131	Mini Drop-in <sup>1</sup>	\$ 1,785
140	Small Undermount	\$ 4,045
141	Small Drop-in <sup>1</sup>	\$ 4,045
170	Undermount	\$ 4,045
171	Drop-in <sup>1</sup>	\$ 4,045
* 1 Drop-in color options NOTE below.		
1 Items 131, 141 and 171 drop-in basins with Polished finish are <i>only</i> offered in Bronze, Grey, Black, Cobalt and Blue polished glass, or any color with White Lami, Mirror, Satin Etched, Chalk or Pearl finishes.		

B Glass Color	
All Vitraform glass has color at the edge. None are devoid of color.	
Color Group 1	
Item	Color
C	Clear
S	Starphire®
Z	Bronze
G	Grey
K	Black
Color Group 2	
Item	Color
P	Peach
A	Azurlite®
X	Solex®
Color Group 3	
Item	Color
T	Cobalt
B	Blue
L	Cristal
Q	Cristal Antiq
For White color specify Starphire glass in Color Group 1 with White Lami Finish in Column C.	

C Glass Finish		
Item	Finish	Add
P	Polished	\$ 00
F	Frosted <sup>1</sup>	\$ 135
O	White Lami <sup>3 4</sup>	\$ 135
S	Satin Etched <sup>2</sup>	\$ 265
M	Mirror <sup>3</sup>	\$ 725
H	Chalk <sup>3 4</sup>	\$ 400
E	Pearl <sup>3</sup>	\$ 990
1 Frosted finish on bottom surface only. 2 Satin Etched finish on inside and outside surface. 3 White Lami, Mirror, Chalk or Pearl Finish not available on Black. 4 White Lami or Chalk Finish not available on Cobalt.		

D Overflow	
Overflow required but NOT included. Order separately. See Overflow column at right.	
Item	Overflow
F	Overflow

E With Engraving Add	
Item	Engraving
00	Request information on engraved designs.

Overflow				
Required. Order separately. See <b>Order Example</b> at lower left of page.				
See Metal Finish Codes below.				
Item	Price			
Overflow	1	2	3	4
918.XX Rectangular	\$ 255	\$ 255	\$ 260	\$ 285
Drain Optional. Order separately.				
See Metal Finish Codes below.				
Item	Price			
Grid Strainer Set	1	2	3	4
810.XX w US PTrap	\$ 330	\$ 575	\$ 750	\$ 820
810.XX.S w Siphon	\$ 455	\$ 670	\$ 855	\$ 920
Dome Open Set				
860.XX w US PTrap	\$ 330	\$ 575	\$ 750	\$ 820
860.XX.S w Siphon	\$ 455	\$ 670	\$ 855	\$ 920
Dome Pop-up Set				
862.XX w US PTrap	\$ 330	\$ 575	\$ 750	\$ 820
862.XX.S w Siphon	\$ 455	\$ 670	\$ 855	\$ 920
Metal Finish Codes				
1	2	3	4	
10 Pol. Chrome	12 Pol. Nickel 20 Sat. Chrome 22 Sat. Nickel	15 ORB 16 Pol. Brass*	13 Pol. Gold* 23 Sat. Gold*	
* Brass and Gold Finishes are PVD.				



Order Example	A	B	C	D	E	Select an option in each column A-E including Overflow (required) and Drain (optional).
Basin Item No.	170	S	F	F	00	
Basin Price	\$ 3,060	-	\$ 135	-	-	Basin Price \$ 3,195
	Rect Undermount	Starphire	Frosted	Overflow	No Engraving	
Overflow Item No.	918	10	Rect Overflow / Pol. Chrome Metal Finish (10)			Overflow Price \$ + 255
Drain Item No.	860	10	Dome Open Set / Overflow / US PTrap / Pol. Chrome Metal Finish (10)			Drain Price \$ + 330
						Total Price \$ 3,780

**Standard Basin / Rectangular Without Overflow** To order, select an option in each of columns A–E. Order overflow and Drain separately. Include Item No. and Price. See Example at bottom of page. Retail Price List

A Select Type of Basin	B Glass Color	C Glass Finish	D Drain Collar	E With Engraving Add	Drain Collar																																																																																																																																																																																																																
<p>Price based on Color Groups. Mini Rectangular Basin 12.25 x 15.25 in. Small Rectangular Basin 17 x 22 in. Rectangular Basin 18 x 24 in.</p> <table border="1" style="width: 100%; border-collapse: collapse;"> <thead> <tr> <th colspan="3">Color Group 1 Pricing</th> </tr> <tr> <th>Item</th> <th>Description</th> <th>Price</th> </tr> </thead> <tbody> <tr><td>130</td><td>Mini Undermount</td><td>\$ 1,100</td></tr> <tr><td>131</td><td>Mini Drop-in <sup>1</sup></td><td>\$ 1,100</td></tr> <tr><td>140</td><td>Small Undermount</td><td>\$ 3,060</td></tr> <tr><td>141</td><td>Small Drop-in <sup>1</sup></td><td>\$ 3,060</td></tr> <tr><td>170</td><td>Undermount</td><td>\$ 3,060</td></tr> <tr><td>171</td><td>Drop-in <sup>1</sup></td><td>\$ 3,060</td></tr> </tbody> </table> <p>* 1 Drop-in color options NOTE below.</p> <table border="1" style="width: 100%; border-collapse: collapse;"> <thead> <tr> <th colspan="3">Color Group 2 Pricing</th> </tr> <tr> <th>Item</th> <th>Description</th> <th>Price</th> </tr> </thead> <tbody> <tr><td>130</td><td>Mini Undermount</td><td>\$ 1,330</td></tr> <tr><td>131</td><td>Mini Drop-in <sup>1</sup></td><td>\$ 1,330</td></tr> <tr><td>140</td><td>Small Undermount</td><td>\$ 3,195</td></tr> <tr><td>141</td><td>Small Drop-in <sup>1</sup></td><td>\$ 3,195</td></tr> <tr><td>170</td><td>Undermount</td><td>\$ 3,195</td></tr> <tr><td>171</td><td>Drop-in <sup>1</sup></td><td>\$ 3,195</td></tr> </tbody> </table> <p>* 1 Drop-in color options NOTE below.</p> <table border="1" style="width: 100%; border-collapse: collapse;"> <thead> <tr> <th colspan="3">Color Group 3 Pricing</th> </tr> <tr> <th>Item</th> <th>Description</th> <th>Price</th> </tr> </thead> <tbody> <tr><td>130</td><td>Mini Undermount</td><td>\$ 1,785</td></tr> <tr><td>131</td><td>Mini Drop-in <sup>1</sup></td><td>\$ 1,785</td></tr> <tr><td>140</td><td>Small Undermount</td><td>\$ 4,045</td></tr> <tr><td>141</td><td>Small Drop-in <sup>1</sup></td><td>\$ 4,045</td></tr> <tr><td>170</td><td>Undermount</td><td>\$ 4,045</td></tr> <tr><td>171</td><td>Drop-in <sup>1</sup></td><td>\$ 4,045</td></tr> </tbody> </table> <p>* 1 Drop-in color options NOTE below.</p> <p>1 Items 131, 141 and 171 drop-in basins with Polished finish are <i>only</i> offered in Bronze, Grey, Black, Cobalt and Blue polished glass, or any color with White Lami, Mirror, Satin Etched, Chalk or Pearl finishes.</p>	Color Group 1 Pricing			Item	Description	Price	130	Mini Undermount	\$ 1,100	131	Mini Drop-in <sup>1</sup>	\$ 1,100	140	Small Undermount	\$ 3,060	141	Small Drop-in <sup>1</sup>	\$ 3,060	170	Undermount	\$ 3,060	171	Drop-in <sup>1</sup>	\$ 3,060	Color Group 2 Pricing			Item	Description	Price	130	Mini Undermount	\$ 1,330	131	Mini Drop-in <sup>1</sup>	\$ 1,330	140	Small Undermount	\$ 3,195	141	Small Drop-in <sup>1</sup>	\$ 3,195	170	Undermount	\$ 3,195	171	Drop-in <sup>1</sup>	\$ 3,195	Color Group 3 Pricing			Item	Description	Price	130	Mini Undermount	\$ 1,785	131	Mini Drop-in <sup>1</sup>	\$ 1,785	140	Small Undermount	\$ 4,045	141	Small Drop-in <sup>1</sup>	\$ 4,045	170	Undermount	\$ 4,045	171	Drop-in <sup>1</sup>	\$ 4,045	<p>All Vitraform glass has color at the edge. None are devoid of color.</p> <table border="1" style="width: 100%; border-collapse: collapse;"> <thead> <tr> <th colspan="2">Color Group 1</th> </tr> <tr> <th>Item</th> <th>Color</th> </tr> </thead> <tbody> <tr><td>C</td><td>Clear</td></tr> <tr><td>S</td><td>Starphire®</td></tr> <tr><td>Z</td><td>Bronze</td></tr> <tr><td>G</td><td>Grey</td></tr> <tr><td>K</td><td>Black</td></tr> </tbody> </table> <table border="1" style="width: 100%; border-collapse: collapse;"> <thead> <tr> <th colspan="2">Color Group 2</th> </tr> <tr> <th>Item</th> <th>Color</th> </tr> </thead> <tbody> <tr><td>P</td><td>Peach</td></tr> <tr><td>A</td><td>Azurlite®</td></tr> <tr><td>X</td><td>Solex®</td></tr> </tbody> </table> <table border="1" style="width: 100%; border-collapse: collapse;"> <thead> <tr> <th colspan="2">Color Group 3</th> </tr> <tr> <th>Item</th> <th>Color</th> </tr> </thead> <tbody> <tr><td>T</td><td>Cobalt</td></tr> <tr><td>B</td><td>Blue</td></tr> <tr><td>L</td><td>Cristal</td></tr> <tr><td>Q</td><td>Cristal Antiq</td></tr> </tbody> </table> <p>For White color specify Starphire glass in Color Group 1 with White Lami Finish in Column C.</p>	Color Group 1		Item	Color	C	Clear	S	Starphire®	Z	Bronze	G	Grey	K	Black	Color Group 2		Item	Color	P	Peach	A	Azurlite®	X	Solex®	Color Group 3		Item	Color	T	Cobalt	B	Blue	L	Cristal	Q	Cristal Antiq	<table border="1" style="width: 100%; border-collapse: collapse;"> <thead> <tr> <th>Item</th> <th>Finish</th> <th>Add</th> </tr> </thead> <tbody> <tr><td>P</td><td>Polished</td><td>\$ 00</td></tr> <tr><td>F</td><td>Frosted <sup>1</sup></td><td>\$ 135</td></tr> <tr><td>O</td><td>White Lami <sup>3 4</sup></td><td>\$ 135</td></tr> <tr><td>S</td><td>Satin Etched <sup>2</sup></td><td>\$ 265</td></tr> <tr><td>M</td><td>Mirror <sup>3</sup></td><td>\$ 725</td></tr> <tr><td>H</td><td>Chalk <sup>3 4</sup></td><td>\$ 400</td></tr> <tr><td>E</td><td>Pearl <sup>3</sup></td><td>\$ 990</td></tr> </tbody> </table> <p>1 Frosted finish on bottom surface only. 2 Satin Etched finish on inside and outside surface. 3 White Lami, Mirror, Chalk or Pearl Finish not available on Black. 4 White Lami or Chalk Finish not available on Cobalt.</p> <div style="text-align: center; margin-top: 20px;">  </div>	Item	Finish	Add	P	Polished	\$ 00	F	Frosted <sup>1</sup>	\$ 135	O	White Lami <sup>3 4</sup>	\$ 135	S	Satin Etched <sup>2</sup>	\$ 265	M	Mirror <sup>3</sup>	\$ 725	H	Chalk <sup>3 4</sup>	\$ 400	E	Pearl <sup>3</sup>	\$ 990	<p>Drain Collar is required but is NOT included. Order separately. See Drain Collar column at right.</p> <table border="1" style="width: 100%; border-collapse: collapse;"> <thead> <tr> <th>Item</th> <th>Engraving</th> </tr> </thead> <tbody> <tr><td>C</td><td>Drain Collar</td></tr> <tr><td>00</td><td>Request information on engraved designs.</td></tr> </tbody> </table>	Item	Engraving	C	Drain Collar	00	Request information on engraved designs.	<p>Required. Order separately. See <b>Order Example</b> at lower left of page.</p> <p>See Metal Finish Codes below.</p> <table border="1" style="width: 100%; border-collapse: collapse;"> <thead> <tr> <th>Item</th> <th colspan="4">Price</th> </tr> <tr> <th>Drain Collar</th> <th>1</th> <th>2</th> <th>3</th> <th>4</th> </tr> </thead> <tbody> <tr> <td>900.XX</td> <td>\$ 50</td> <td>\$ 50</td> <td>\$ 55</td> <td>\$ 60</td> </tr> </tbody> </table> <p><b>Drain</b> Optional. Order separately.</p> <p>See Metal Finish Codes below.</p> <table border="1" style="width: 100%; border-collapse: collapse;"> <thead> <tr> <th>Item</th> <th colspan="4">Price</th> </tr> <tr> <th>Grid Strainer Set</th> <th>1</th> <th>2</th> <th>3</th> <th>4</th> </tr> </thead> <tbody> <tr> <td>811.XX w US PTrap</td> <td>\$ 330</td> <td>\$ 575</td> <td>\$ 750</td> <td>\$ 820</td> </tr> <tr> <td>811.XX.S w Siphon</td> <td>\$ 455</td> <td>\$ 670</td> <td>\$ 855</td> <td>\$ 920</td> </tr> </tbody> </table> <p><b>Dome Open Set</b></p> <table border="1" style="width: 100%; border-collapse: collapse;"> <tbody> <tr> <td>861.XX w US PTrap</td> <td>\$ 330</td> <td>\$ 575</td> <td>\$ 750</td> <td>\$ 820</td> </tr> <tr> <td>861.XX.S w Siphon</td> <td>\$ 455</td> <td>\$ 670</td> <td>\$ 855</td> <td>\$ 920</td> </tr> </tbody> </table> <p><b>Dome Pop-up Set</b></p> <table border="1" style="width: 100%; border-collapse: collapse;"> <tbody> <tr> <td>863.XX w US PTrap</td> <td>\$ 330</td> <td>\$ 575</td> <td>\$ 750</td> <td>\$ 820</td> </tr> <tr> <td>863.XX.S w Siphon</td> <td>\$ 455</td> <td>\$ 670</td> <td>\$ 855</td> <td>\$ 920</td> </tr> </tbody> </table> <p><b>Metal Finish Codes</b></p> <table border="1" style="width: 100%; border-collapse: collapse;"> <thead> <tr> <th>1</th> <th>2</th> <th>3</th> <th>4</th> </tr> </thead> <tbody> <tr> <td>10 Pol. Chrome</td> <td>12 Pol. Nickel</td> <td>15 ORB</td> <td>13 Pol. Gold*</td> </tr> <tr> <td></td> <td>20 Sat. Chrome</td> <td>16 Pol. Brass*</td> <td>23 Sat. Gold*</td> </tr> <tr> <td></td> <td>22 Sat. Nickel</td> <td></td> <td></td> </tr> </tbody> </table> <p>* Brass and Gold Finishes are PVD.</p>	Item	Price				Drain Collar	1	2	3	4	900.XX	\$ 50	\$ 50	\$ 55	\$ 60	Item	Price				Grid Strainer Set	1	2	3	4	811.XX w US PTrap	\$ 330	\$ 575	\$ 750	\$ 820	811.XX.S w Siphon	\$ 455	\$ 670	\$ 855	\$ 920	861.XX w US PTrap	\$ 330	\$ 575	\$ 750	\$ 820	861.XX.S w Siphon	\$ 455	\$ 670	\$ 855	\$ 920	863.XX w US PTrap	\$ 330	\$ 575	\$ 750	\$ 820	863.XX.S w Siphon	\$ 455	\$ 670	\$ 855	\$ 920	1	2	3	4	10 Pol. Chrome	12 Pol. Nickel	15 ORB	13 Pol. Gold*		20 Sat. Chrome	16 Pol. Brass*	23 Sat. Gold*		22 Sat. Nickel		
Color Group 1 Pricing																																																																																																																																																																																																																					
Item	Description	Price																																																																																																																																																																																																																			
130	Mini Undermount	\$ 1,100																																																																																																																																																																																																																			
131	Mini Drop-in <sup>1</sup>	\$ 1,100																																																																																																																																																																																																																			
140	Small Undermount	\$ 3,060																																																																																																																																																																																																																			
141	Small Drop-in <sup>1</sup>	\$ 3,060																																																																																																																																																																																																																			
170	Undermount	\$ 3,060																																																																																																																																																																																																																			
171	Drop-in <sup>1</sup>	\$ 3,060																																																																																																																																																																																																																			
Color Group 2 Pricing																																																																																																																																																																																																																					
Item	Description	Price																																																																																																																																																																																																																			
130	Mini Undermount	\$ 1,330																																																																																																																																																																																																																			
131	Mini Drop-in <sup>1</sup>	\$ 1,330																																																																																																																																																																																																																			
140	Small Undermount	\$ 3,195																																																																																																																																																																																																																			
141	Small Drop-in <sup>1</sup>	\$ 3,195																																																																																																																																																																																																																			
170	Undermount	\$ 3,195																																																																																																																																																																																																																			
171	Drop-in <sup>1</sup>	\$ 3,195																																																																																																																																																																																																																			
Color Group 3 Pricing																																																																																																																																																																																																																					
Item	Description	Price																																																																																																																																																																																																																			
130	Mini Undermount	\$ 1,785																																																																																																																																																																																																																			
131	Mini Drop-in <sup>1</sup>	\$ 1,785																																																																																																																																																																																																																			
140	Small Undermount	\$ 4,045																																																																																																																																																																																																																			
141	Small Drop-in <sup>1</sup>	\$ 4,045																																																																																																																																																																																																																			
170	Undermount	\$ 4,045																																																																																																																																																																																																																			
171	Drop-in <sup>1</sup>	\$ 4,045																																																																																																																																																																																																																			
Color Group 1																																																																																																																																																																																																																					
Item	Color																																																																																																																																																																																																																				
C	Clear																																																																																																																																																																																																																				
S	Starphire®																																																																																																																																																																																																																				
Z	Bronze																																																																																																																																																																																																																				
G	Grey																																																																																																																																																																																																																				
K	Black																																																																																																																																																																																																																				
Color Group 2																																																																																																																																																																																																																					
Item	Color																																																																																																																																																																																																																				
P	Peach																																																																																																																																																																																																																				
A	Azurlite®																																																																																																																																																																																																																				
X	Solex®																																																																																																																																																																																																																				
Color Group 3																																																																																																																																																																																																																					
Item	Color																																																																																																																																																																																																																				
T	Cobalt																																																																																																																																																																																																																				
B	Blue																																																																																																																																																																																																																				
L	Cristal																																																																																																																																																																																																																				
Q	Cristal Antiq																																																																																																																																																																																																																				
Item	Finish	Add																																																																																																																																																																																																																			
P	Polished	\$ 00																																																																																																																																																																																																																			
F	Frosted <sup>1</sup>	\$ 135																																																																																																																																																																																																																			
O	White Lami <sup>3 4</sup>	\$ 135																																																																																																																																																																																																																			
S	Satin Etched <sup>2</sup>	\$ 265																																																																																																																																																																																																																			
M	Mirror <sup>3</sup>	\$ 725																																																																																																																																																																																																																			
H	Chalk <sup>3 4</sup>	\$ 400																																																																																																																																																																																																																			
E	Pearl <sup>3</sup>	\$ 990																																																																																																																																																																																																																			
Item	Engraving																																																																																																																																																																																																																				
C	Drain Collar																																																																																																																																																																																																																				
00	Request information on engraved designs.																																																																																																																																																																																																																				
Item	Price																																																																																																																																																																																																																				
Drain Collar	1	2	3	4																																																																																																																																																																																																																	
900.XX	\$ 50	\$ 50	\$ 55	\$ 60																																																																																																																																																																																																																	
Item	Price																																																																																																																																																																																																																				
Grid Strainer Set	1	2	3	4																																																																																																																																																																																																																	
811.XX w US PTrap	\$ 330	\$ 575	\$ 750	\$ 820																																																																																																																																																																																																																	
811.XX.S w Siphon	\$ 455	\$ 670	\$ 855	\$ 920																																																																																																																																																																																																																	
861.XX w US PTrap	\$ 330	\$ 575	\$ 750	\$ 820																																																																																																																																																																																																																	
861.XX.S w Siphon	\$ 455	\$ 670	\$ 855	\$ 920																																																																																																																																																																																																																	
863.XX w US PTrap	\$ 330	\$ 575	\$ 750	\$ 820																																																																																																																																																																																																																	
863.XX.S w Siphon	\$ 455	\$ 670	\$ 855	\$ 920																																																																																																																																																																																																																	
1	2	3	4																																																																																																																																																																																																																		
10 Pol. Chrome	12 Pol. Nickel	15 ORB	13 Pol. Gold*																																																																																																																																																																																																																		
	20 Sat. Chrome	16 Pol. Brass*	23 Sat. Gold*																																																																																																																																																																																																																		
	22 Sat. Nickel																																																																																																																																																																																																																				
<table border="1" style="width: 100%; border-collapse: collapse;"> <thead> <tr> <th>Order Example</th> <th>A</th> <th>B</th> <th>C</th> <th>D</th> <th>E</th> <th></th> </tr> </thead> <tbody> <tr> <td>Basin Item No.</td> <td>171</td> <td>B</td> <td>S</td> <td>C</td> <td>00</td> <td></td> </tr> <tr> <td>Basin Price</td> <td>\$ 4,045</td> <td>-</td> <td>\$ 265</td> <td>-</td> <td>-</td> <td>Basin Price \$ 4,310</td> </tr> <tr> <td></td> <td colspan="2" style="text-align: center;">Rect Drop-In Basin Blue</td> <td colspan="2" style="text-align: center;">Satin Etched Drain Collar</td> <td colspan="2" style="text-align: center;">No Engraving</td> </tr> <tr> <td>Drain Collar Item No.</td> <td>900</td> <td>10</td> <td colspan="3">Drain Collar / Pol. Chrome Metal Finish (10)</td> <td>Drain Collar Price \$ + 50</td> </tr> <tr> <td>Drain Item No.</td> <td>861</td> <td>10S</td> <td colspan="3">Dome Drain Set / Siphon / Pol. Chrome Metal Finish (10)</td> <td>Drain Price \$ + 455</td> </tr> <tr> <td></td> <td colspan="5"></td> <td>Total Price \$ 4,815</td> </tr> </tbody> </table>					Order Example	A	B	C	D	E		Basin Item No.	171	B	S	C	00		Basin Price	\$ 4,045	-	\$ 265	-	-	Basin Price \$ 4,310		Rect Drop-In Basin Blue		Satin Etched Drain Collar		No Engraving		Drain Collar Item No.	900	10	Drain Collar / Pol. Chrome Metal Finish (10)			Drain Collar Price \$ + 50	Drain Item No.	861	10S	Dome Drain Set / Siphon / Pol. Chrome Metal Finish (10)			Drain Price \$ + 455							Total Price \$ 4,815																																																																																																																																																																
Order Example	A	B	C	D	E																																																																																																																																																																																																																
Basin Item No.	171	B	S	C	00																																																																																																																																																																																																																
Basin Price	\$ 4,045	-	\$ 265	-	-	Basin Price \$ 4,310																																																																																																																																																																																																															
	Rect Drop-In Basin Blue		Satin Etched Drain Collar		No Engraving																																																																																																																																																																																																																
Drain Collar Item No.	900	10	Drain Collar / Pol. Chrome Metal Finish (10)			Drain Collar Price \$ + 50																																																																																																																																																																																																															
Drain Item No.	861	10S	Dome Drain Set / Siphon / Pol. Chrome Metal Finish (10)			Drain Price \$ + 455																																																																																																																																																																																																															
						Total Price \$ 4,815																																																																																																																																																																																																															

## Standard Basin / Rectangular With Overflow

To order, select an option in each of columns A-E. Order Drain separately. Include Item No. and Price. See Example at bottom of page.

Retail Price List

A Select Type of Basin	
Price based on Color Groups. Mini Rectangular Basin 12.25 x 15.25 in. Small Rectangular Basin 17 x 22 in. Rectangular Basin 18 x 24 in.	
Basin Size	
Item	
130	Mini Undermount
131	Mini Drop-in
140	Small Rectangular Undermount
141	Small Rectangular Drop-in
170	Rectangular Undermount
171	Rectangular Drop-in
Graphique, Fragment, Cubiste, Matte and Lustre finishes may be installed as drop-in.	

B Glass Color	
All Vitraform glass has color at the edge. None are devoid of color.	
Color Group 1	
Item	Color
K	Black
Black used for Graphique and Fragment patterns.	
Color Group 3	
Item	Color
Q	Cristal Antiq
Cristal Antique used for Vapeur, Cubiste, Matte and Luster Patterns.	

C Glass Finish	
Item	Finish
R	Rose Gold
W	White Gold

D Overflow	
Overflow required but NOT included. Order separately. See Overflow column at right.	
Item	
F	Overflow

E Gilded Finish			
This page is for Gilded Finishes only.			
Color Group 1		Price	Price
Item	Pattern	130, 131	140, 141, 170, 171
GR	Graphique <sup>1</sup>	\$ *	\$ *
FR	Fragment <sup>1</sup>	\$ 2,055	\$ 4,535
<sup>1</sup> These patterns available on Black glass only. <sup>*</sup> Request quotation from factory.			
Color Group 3		Price	Price
Item	Pattern	130, 131	140, 141, 170, 171
VA	Vapeur <sup>2</sup>	\$ 5,810	\$ 9,195
CU	Cubiste <sup>2</sup>	\$ 5,810	\$ 9,195
MA	Matte <sup>2</sup>	\$ 4,660	\$ 7,245
LU	Lustre <sup>2</sup>	\$ 6,230	\$ 8,665
<sup>2</sup> These patterns available on Cristal Antique glass only.			



Overflow				
Required. Order separately. See <b>Order Example</b> at lower left of page.				
See Metal Finish Codes below.				
Item	Price			
Overflow	1	2	3	4
918.XX Rectangular	\$ 255	\$ 255	\$ 260	\$ 285
Drain Optional. Order separately.				
See Metal Finish Codes below.				
Item	Price			
Grid Strainer Set	1	2	3	4
810.XX w US PTrap	\$ 330	\$ 575	\$ 750	\$ 820
810.XX.S w Siphon	\$ 455	\$ 670	\$ 855	\$ 920
Dome Open Set				
860.XX w US PTrap	\$ 330	\$ 575	\$ 750	\$ 820
860.XX.S w Siphon	\$ 455	\$ 670	\$ 855	\$ 920
Dome Pop-up Set				
862.XX w US PTrap	\$ 330	\$ 575	\$ 750	\$ 820
862.XX.S w Siphon	\$ 455	\$ 670	\$ 855	\$ 920
Metal Finish Codes				
1	2	3	4	
10 Pol. Chrome	12 Pol. Nickel 20 Sat. Chrome 22 Sat. Nickel	15 ORB 16 Pol. Brass*	13 Pol. Gold* 23 Sat. Gold*	
* Brass and Gold Finishes are PVD.				

Order Example	A	B	C	D	E	
Basin Item No.	170	Q	W	F	LU	Select an option in each column A-E including Overflow (required) and Drain (optional).
Basin Price	-	-	-	-	8,665	Basin Price \$ 8,665
	Rect Undermount	Cristal Antiq	White Gold	Overflow	Lustre Pattern	
Overflow Item No.	918	10	Rect Overflow / Pol. Chrome Metal Finish (10)			Overflow Price \$ + 255
Drain Item No.	860	10S	Dome Drain / Overflow / Siphon / Pol. Chrome Metal Finish (10)			Drain Price \$ + 455
					Total Price	\$ 9,375



Standard Basin / Rectangular Without Overflow Retail Price List

A Select Type of Basin	
Price based on Color Groups. Mini Rectangular Basin 12.25 x 15.25 in. Small Rectangular Basin 17 x 22 in. Rectangular Basin 18 x 24 in.	
Basin Size	
Item	
130	Mini Undermount
131	Mini Drop-in
140	Small Rectangular Undermount
141	Small Rectangular Drop-in
170	Rectangular Undermount
171	Rectangular Drop-in
Graphique, Fragment, Cubiste, Matte and Lustre finishes may be installed as drop-in.	

B Glass Color	
All Vitraform glass has color at the edge. None are devoid of color.	
Color Group 1	
Item	Color
K	Black
Black used for Graphique and Fragment patterns.	
Color Group 3	
Item	Color
Q	Cristal Antiq
Cristal Antique used for Vapeur, Cubiste, Matte and Luster Patterns.	

C Glass Finish	
Item	Finish
R	Rose Gold
W	White Gold

D Drain Collar	
Drain Collar is required but is NOT included. Order separately. See Drain Collar column at right.	
Item	
C	Drain Collar

E Gilded Finish			
This page is for Gilded Finishes only.			
Color Group 1		Price	Price
Item	Pattern	130, 131	140, 141, 170, 171
GR	Graphique <sup>1</sup>	\$ *	\$ *
FR	Fragment <sup>1</sup>	\$ 2,055	\$ 4,535
<sup>1</sup> These patterns available on Black glass only. <sup>*</sup> Request quotation from factory.			
Color Group 3		Price	Price
Item	Pattern	130, 131	140, 141, 170, 171
VA	Vapeur <sup>2</sup>	\$ 5,810	\$ 9,195
CU	Cubiste <sup>2</sup>	\$ 5,810	\$ 9,195
MA	Matte <sup>2</sup>	\$ 4,660	\$ 7,245
LU	Lustre <sup>2</sup>	\$ 6,230	\$ 8,665
<sup>2</sup> These patterns available on Cristal Antique glass only.			



Drain Collar				
Required. Order separately. See <b>Order Example</b> at lower left of page.				
See Metal Finish Codes below.				
Item	Price			
Drain Collar	1	2	3	4
900.XX	\$ 50	\$ 50	\$ 55	\$ 60
Drain Optional. Order separately.				
See Metal Finish Codes below.				
Item	Price			
Grid Strainer Set	1	2	3	4
811.XX w US PTrap	\$ 330	\$ 575	\$ 750	\$ 820
811.XX.S w Siphon	\$ 455	\$ 670	\$ 855	\$ 920
Dome Open Set				
861.XX w US PTrap	\$ 330	\$ 575	\$ 750	\$ 820
861.XX.S w Siphon	\$ 455	\$ 670	\$ 855	\$ 920
Dome Pop-up Set				
863.XX w US PTrap	\$ 330	\$ 575	\$ 750	\$ 820
863.XX.S w Siphon	\$ 455	\$ 670	\$ 855	\$ 920
Metal Finish Codes				
1	2	3	4	
10 Pol. Chrome	12 Pol. Nickel 20 Sat. Chrome 22 Sat. Nickel	15 ORB 16 Pol. Brass*	13 Pol. Gold* 23 Sat. Gold*	
* Brass and Gold Finishes are PVD.				

Order Example	A	B	C	D	E	
Basin Item No.	171	K	W	C	FR	Select an option in each column A-E including Drain Collar (required) and Drain (optional).
Basin Price	-	-	-	-	\$ 4,535	Basin Price \$ 4,535
	Rect Drop-In Basin	Black	White Gold	White Gold	Fragment Pattern	Drain Collar
Drain Collar Item No.	900	10	Drain Collar / Pol. Chrome Metal Finish (10)		Drain Collar Price	\$ + 50
Drain Item No.	861	10S	Dome Drain Set / Siphon / Pol. Chrome Metal Finish (10)		Drain Price	\$ + 455
					Total Price	\$ 5,040



Rimless Undermount Basin



Rimless Undermount Basin in Crystal Antique with Rose Gold Cubiste Finish.  
Shown with Countertop in Black.



Oval Rimless Undermount Basin in Cristal Polished with 1930 Engraving.  
Shown with Countertop in Black.

Rimless Undermount / Round With Overflow

To order, select an option in each of columns A-E. Order overflow and Drain separately. Include Item No. and Price. See Example at bottom of page.

Retail Price List

A Select Type of Basin			B Glass Color	
Price based on Color Groups.			All Vitraform glass has color at the edge. None are devoid of color.	
Color Group 1 Pricing			Color Group 1	
Item	Round	Price	Item	Color
203	Small 13" Cutout	\$ 1,490	C	Clear
213	Large 15" Cutout	\$ 1,560	S	Starphire®
			Z	Bronze
			G	Grey
			K	Black
Color Group 2 Pricing			Color Group 2	
Item	Round	Price	Item	Color
203	Small 13" Cutout	\$ 1,720	P	Peach
213	Large 15" Cutout	\$ 1,790	A	Azurlite®
			X	Solex®
Color Group 3 Pricing			Color Group 3	
Item	Round	Price	Item	Color
203	Small 13" Cutout	\$ 2,240	T	Cobalt
213	Large 15" Cutout	\$ 2,325	B	Blue
			L	Cristal
			Q	Cristal Antiq
			For White color specify Starphire glass in Color Group 1 with White Lami Finish in Column C.	

C Glass Finish		
Item	Finish	Add
P	Polished	\$ 00
F	Frosted <sup>1</sup>	\$ 50
O	White Lami <sup>3,4</sup>	\$ 50
S	Satin Etched <sup>2</sup>	\$ 135
M	Mirror <sup>3</sup>	\$ 365
H	Chalk <sup>3,4</sup>	\$ 180
E	Pearl <sup>3</sup>	\$ 495
<sup>1</sup> Frosted finish on bottom surface only. <sup>2</sup> Satin Etched finish on inside and outside surface. <sup>3</sup> White Lami, Mirror, Chalk or Pearl Finish not available on Black. <sup>4</sup> White Lami or Chalk Finish not available on Cobalt. NOTE: FINISHES FOR ENGRAVINGS Frosted finish recommended for Undermount basins with engraving. For Polished finish contact factory. White Lami, Satin Etched, Mirror, Chalk or Pearl finishes cannot be engraved. NOTE: Engraving on Black, Cobalt and Black & White are not recommended.		

D Overflow	
Overflow required but NOT included. Order separately. See Overflow column at right.	
Item	
F	Overflow

E With Engraving Add			
See NOTE in column C for available finishes on engraved basins.			
Item	Engraving	Small Add	Large Add
00	None	\$ 00	\$ 00
11	Empire	\$ 1,500	\$ 1,705
12	Floral	\$ 1,175	\$ 1,385
13	Victorian	\$ 1,500	\$ 1,705
14	Deco	\$ 1,500	\$ 1,705
15	Tulip	\$ 1,500	\$ 1,705
16	TulipBorder	\$ 1,385	\$ 1,595
17	Traditional	\$ 1,385	\$ 1,595
18	Roman	\$ 1,285	\$ 1,495
20	Moderne	\$ 1,500	\$ 1,705
25	1960	\$ 1,285	\$ 1,495
26	1930	\$ 1,865	\$ 2,080
28	Fine Lines	\$ 1,330	\$ 1,545
29	Bamboo	\$ 1,330	\$ 1,545
30	Battuto	\$ 2,345	\$ 2,560
31	Confetti	\$ 1,810	\$ 2,025
33	Zebra	\$ 1,330	\$ 1,545
34	Tebori	\$ 2,130	\$ 2,345
36	Arabesque	\$ 1,970	\$ 2,185
38	Palmier	\$ 3,035	\$ 3,250
40	Entre Deux	\$ 1,700	\$ 1,935
43	Eolienne vert.	\$ 2,130	\$ 2,345
44	Eolienne hor.	\$ 2,130	\$ 2,345
45	Emboss	\$ 2,130	\$ 2,345

Overflow					
Required. Order separately. See Order Example at lower left of page.					
See Metal Finish Codes below.					
Item	Price	1	2	3	4
911.XX Small Round	\$ 255	\$ 255	\$ 260	\$ 285	
912.XX Large Round	\$ 255	\$ 255	\$ 260	\$ 285	
Drain Optional. Order separately.					
See Metal Finish Codes below.					
Item	Price	1	2	3	4
810.XX w US PTrap	\$ 330	\$ 575	\$ 750	\$ 820	
810.XX.S w Siphon	\$ 455	\$ 670	\$ 855	\$ 920	
Dome Open Set					
860.XX w US PTrap	\$ 330	\$ 575	\$ 750	\$ 820	
860.XX.S w Siphon	\$ 455	\$ 670	\$ 855	\$ 920	
Dome Pop-up Set					
862.XX w US PTrap	\$ 330	\$ 575	\$ 750	\$ 820	
862.XX.S w Siphon	\$ 455	\$ 670	\$ 855	\$ 920	
Metal Finish Codes					
1	2	3	4		
10 Pol. Chrome	12 Pol. Nickel 20 Sat. Chrome 22 Sat. Nickel	15 ORB 16 Pol. Brass*	13 Pol. Gold* 23 Sat. Gold*		
* Brass and Gold Finishes are PVD.					



Order Example	A	B	C	D	E	Engraving Color Upcharge	Select an option in each column A-E including Overflow (required) and Drain (optional).
Basin Item No.	213	P	F	F	20		
Basin Price	\$ 1,790	-	\$ 50	-	\$ 1,705	by Glass Color + \$ 110	Basin Price \$ 3,655
	Lrg. Round Rimless	Peach	Frosted	Overflow	Moderne Engraving		
Overflow Item No.	912	12	Lg Round Overflow / Pol. Nickel Metal Finish (12)			Overflow Price	\$ + 255
Drain Item No.	860	12	Dome Open Set / Overflow / US PTrap / Pol. Nickel Metal Finish (12)			Drain Price	\$ + 575
						Total Price	\$ 4,485

Engraving Color Upcharge	
Upcharges for glass color to be added into price. Does not affect item number.	
Glass Color	Add
Clear, Cristal, Cristal Antiq, Starphire	\$ 00
Bronze, Grey, Peach, Azurlite, Solex, Blue,	\$ 110
NOTE: Engraving on Black or Cobalt are not offered for Rimless Installation. Request assistance.	



Rimless Undermount / Round Without Overflow To order, select an option in each of columns A–E. Order Drain Collar and Drain separately. Include Item No. and Price. See Example at bottom of page. Retail Price List

A Select Type of Basin			B Glass Color		C Glass Finish			D Drain Collar		E With Engraving Add				Drain Collar																			
Price based on Color Groups.			All Vitraform glass has color at the edge. None are devoid of color.					Drain Collar is required but is NOT included. Order separately. See Drain Collar column at right.		See NOTE in column C for available finishes on engraved basins.				Required. Order separately. See <b>Order Example</b> at lower left of page.																			
Color Group 1 Pricing			Color Group 1											See Metal Finish Codes below.																			
Item	Round	Price	Item	Color	Item	Finish	Add	Item		Item	Engraving	Add	Add	Item				Price															
203	Small 13" Cutout	\$ 1,490	C	Clear	P	Polished	\$ 00	C	Drain Collar	00	None	\$ 00	\$ 00	Drain Collar				1 2 3 4															
213	Large 15" Cutout	\$ 1,560	S	Starphire®	F	Frosted <sup>1</sup>	\$ 50					11	Empire	\$ 1,500	\$ 1,705	900.XX				\$ 50 \$ 50 \$ 55 \$ 60													
			Z	Bronze	O	White Lami <sup>3,4</sup>	\$ 50					12	Floral	\$ 1,175	\$ 1,385	Drain Optional. Order separately.				See Metal Finish Codes below.													
			G	Grey	S	Satin Etched <sup>2</sup>	\$ 135					13	Victorian	\$ 1,500	\$ 1,705	Item				Price													
			K	Black	M	Mirror <sup>3</sup>	\$ 365					14	Deco	\$ 1,500	\$ 1,705	Grid Strainer Set				1 2 3 4													
Color Group 2 Pricing			Color Group 2											15	Tulip	\$ 1,500	\$ 1,705	811.XX w US PTrap				\$ 330 \$ 575 \$ 750 \$ 820											
Item	Round	Price	Item	Color	1 Frosted finish on bottom surface only. 2 Satin Etched finish on inside and outside surface. 3 White Lami, Mirror, Chalk or Pearl Finish not available on Black. 4 White Lami or Chalk Finish not available on Cobalt. NOTE: FINISHES FOR ENGRAVINGS Frosted finish recommended for Undermount basins with engraving. For Polished finish contact factory. White Lami, Satin Etched, Mirror, Chalk or Pearl finishes cannot be engraved. NOTE: Engraving on Black, Cobalt and Black & White are not recommended.									16	TulipBorder	\$ 1,385	\$ 1,595	811.XX.S w Siphon				\$ 455 \$ 670 \$ 855 \$ 920											
203	Small 13" Cutout	\$ 1,720	P	Peach										17	Traditional	\$ 1,385	\$ 1,595	Dome Open Set															
213	Large 15" Cutout	\$ 1,790	A	Azurlite®										18	Roman	\$ 1,285	\$ 1,495	861.XX w US PTrap				\$ 330 \$ 575 \$ 750 \$ 820											
			X	Solex®										19	Moderne	\$ 1,500	\$ 1,705	861.XX.S w Siphon				\$ 455 \$ 670 \$ 855 \$ 920											
Color Group 3 Pricing			Color Group 3											20	1960	\$ 1,285	\$ 1,495	Dome Pop-up Set															
Item	Round	Price	Item	Color										25	1930	\$ 1,865	\$ 2,080	863.XX w US PTrap				\$ 330 \$ 575 \$ 750 \$ 820											
203	Small 13" Cutout	\$ 2,240	T	Cobalt										26	Fine Lines	\$ 1,330	\$ 1,545	863.XX.S w Siphon				\$ 455 \$ 670 \$ 855 \$ 920											
213	Large 15" Cutout	\$ 2,325	B	Blue										28	Bamboo	\$ 1,330	\$ 1,545	Metal Finish Codes															
			L	Cristal										29	Battuto	\$ 2,345	\$ 2,560	1 2 3 4															
			Q	Cristal Antiq										30	Confetti	\$ 1,810	\$ 2,025	10 Pol. Chrome				12 Pol. Nickel 20 Sat. Chrome 22 Sat. Nickel				15 ORB 16 Pol. Brass*				13 Pol. Gold* 23 Sat. Gold*			
			For White color specify Starphire glass in Color Group 1 with White Lami Finish in Column C.											33	Zebra	\$ 1,330	\$ 1,545	* Brass and Gold Finishes are PVD.															



Order Example	A	B	C	D	E	Engraving Color Upcharge	Select an option in each column A-E including Drain Collar (required) and Drain (optional).
Basin Item No.	213	S	P	C	26		
Basin Price	\$ 1,560	-	\$ 00	-	\$ 2,080	by Glass Color + \$ 00	Basin Price \$ 3,640
Lrg. Round Rimless		Polished		1930 Engraving			
Starphire		Drain Collar					
Drain Collar Item No.	900	12	Drain Collar / Pol. Nickel Metal Finish (12)			Drain Collar Price	\$ + 50
Drain Item No.	861	12S	Dome Drain Set / Siphon / Pol. Nickel Metal Finish (12)			Drain Price	\$ + 670
						Total Price	\$ 4,360

**Engraving Color Upcharge**

Upcharges for glass color to be added into price. Does not affect item number.

Glass Color	Add
Clear, Cristal, Cristal Antiq, Starphire	\$ 00
Bronze, Grey, Peach, Azurlite, Solex, Blue,	\$ 110

NOTE: Engraving on Black or Cobalt are not offered for Rimless Installation. Request assistance.

Rimless Undermount / Oval With Overflow To order, select an option in each of columns A-E. Order overflow and Drain separately. Include Item No. and Price. See Example at bottom of page. Retail Price List

A Select Type of Basin		
Price based on Color Groups.		
Color Group 1 Pricing		
Item	Oval	Price
253	Small 11 1/2" x 15" Cutout	\$ 1,490
263	Large 13 1/4" x 17 1/4" Cutout	\$ 1,560
Color Group 2 Pricing		
Item	Oval	Price
253	Small 11 1/2" x 15" Cutout	\$ 1,720
263	Large 13 1/4" x 17 1/4" Cutout	\$ 1,790
Color Group 3 Pricing		
Item	Oval	Price
253	Small 11 1/2" x 15" Cutout	\$ 2,240
263	Large 13 1/4" x 17 1/4" Cutout	\$ 2,325

B Glass Color	
All Vitraform glass has color at the edge. None are devoid of color.	
Color Group 1	
Item	Color
C	Clear
S	Starphire®
Z	Bronze
G	Grey
K	Black
Color Group 2	
Item	Color
P	Peach
A	Azurlite®
X	Solex®
Color Group 3	
Item	Color
T	Cobalt
B	Blue
L	Cristal
Q	Cristal Antiq
For White color specify Starphire glass in Color Group 1 with White Lami Finish in Column C.	

C Glass Finish		
Item	Finish	Add
P	Polished	\$ 00
F	Frosted <sup>1</sup>	\$ 50
O	White Lami <sup>3 4</sup>	\$ 50
S	Satin Etched <sup>2</sup>	\$ 135
M	Mirror <sup>3</sup>	\$ 365
H	Chalk <sup>3 4</sup>	\$ 180
E	Pearl <sup>3</sup>	\$ 495
<sup>1</sup> Frosted finish on bottom surface only. <sup>2</sup> Satin Etched finish on inside and outside surface. <sup>3</sup> White Lami, Mirror, Chalk or Pearl Finish not available on Black. <sup>4</sup> White Lami or Chalk Finish not available on Cobalt. NOTE: FINISHES FOR ENGRAVINGS Frosted finish recommended for Undermount basins with engraving. For Polished finish contact factory. White Lami, Satin Etched, Mirror, Chalk or Pearl finishes cannot be engraved. NOTE: Engraving on Black, Cobalt and Black & White are not recommended.		

D Overflow	
Overflow required but NOT included. Order separately. See Overflow column at right.	
Item	Overflow
F	Overflow

E With Engraving Add			
See NOTE in column C for available finishes on engraved basins.			
Item	Engraving	Small Add	Large Add
00	None	\$ 00	\$ 00
11	Empire	\$ 1,705	\$ 1,920
12	Floral	\$ 1,385	\$ 1,595
13	Victorian	\$ 1,705	\$ 1,920
14	Deco	\$ 1,705	\$ 1,920
15	Tulip	\$ 1,705	\$ 1,920
16	TulipBorder	\$ 1,595	\$ 1,815
17	Traditional	\$ 1,595	\$ 1,815
18	Roman	\$ 1,495	\$ 1,705
20	Moderne	N/A	N/A
25	1960	\$ 1,495	\$ 1,705
26	1930	\$ 2,080	\$ 2,295
28	Fine Lines	\$ 1,545	\$ 1,760
29	Bamboo	\$ 1,545	\$ 1,760
30	Battuto	\$ 2,560	\$ 2,770
31	Confetti	\$ 2,025	\$ 2,240
33	Zebra	\$ 1,545	\$ 1,760
34	Tebori	\$ 2,345	\$ 2,560
36	Arabesque	\$ 2,185	\$ 2,395
38	Palmier	\$ 3,250	\$ 3,460
40	Entre Deux	\$ 1,935	\$ 2,165
43	Eolienne vert.	\$ 2,130	\$ 2,345
44	Eolienne hor.	\$ 2,130	\$ 2,345
45	Emboss	\$ 2,130	\$ 2,345

Overflow					
Required. Order separately. See Order Example at lower left of page.					
See Metal Finish Codes below.					
Item	Price	1	2	3	4
916.XX Small Oval	\$ 255	\$ 255	\$ 260	\$ 285	
917.XX Large Oval	\$ 255	\$ 255	\$ 260	\$ 285	
Drain Optional. Order separately.					
See Metal Finish Codes below.					
Item	Price	1	2	3	4
810.XX w US PTrap	\$ 330	\$ 575	\$ 750	\$ 820	
810.XX.S w Siphon	\$ 455	\$ 670	\$ 855	\$ 920	
Dome Open Set					
860.XX w US PTrap	\$ 330	\$ 575	\$ 750	\$ 820	
860.XX.S w Siphon	\$ 455	\$ 670	\$ 855	\$ 920	
Dome Pop-up Set					
862.XX w US PTrap	\$ 330	\$ 575	\$ 750	\$ 820	
862.XX.S w Siphon	\$ 455	\$ 670	\$ 855	\$ 920	
Metal Finish Codes					
1	2	3	4		
10 Pol. Chrome	12 Pol. Nickel	15 ORB	13 Pol. Gold*		
	20 Sat. Chrome	16 Pol. Brass*	23 Sat. Gold*		
	22 Sat. Nickel				
* Brass and Gold Finishes are PVD.					



Order Example	A	B	C	D	E	Engraving Color Upcharge	Select an option in each column A-E including Overflow (required) and Drain (optional).
Basin Item No.	263	L	P	F	30		
Basin Price	\$ 2,325	-	\$ 00	-	\$ 2,770	by Glass Color + \$ 00	Basin Price \$ 5,095
	Lrg. Oval Rimless	Cristal	Polished	Battuto Engraving	Overflow		
Overflow Item No.	917	13	Lg Oval Overflow / PVD Pol. Gold Metal Finish (13)			Overflow Price	\$ + 285
Drain Item No.	860	13	Dome Open Set / Overflow / US PTrap / PVD Pol. Gold Metal Finish (13)			Drain Price	\$ + 820
						Total Price	\$ 6,200

Engraving Color Upcharge	
Upcharges for glass color to be added into price. Does not affect item number.	
Glass Color	Add
Clear, Cristal, Cristal Antiq, Starphire	\$ 00
Bronze, Grey, Peach, Azurlite, Solex, Blue,	\$ 110
NOTE: Engraving on Black or Cobalt are not offered for Rimless installation. Request assistance.	

Rimless Undermount / Oval Without Overflow To order, select an option in each of columns A-E. Order Drain Collar and Drain separately. Include Item No. and Price. See Example at bottom of page. Retail Price List

**A Select Type of Basin**

Price based on Color Groups.

**Color Group 1 Pricing**

Item	Oval	Price
253	Small 11 1/2" x 15" Cutout	\$ 1,490
263	Large 13 1/4" x 17 1/4" Cutout	\$ 1,560

**Color Group 2 Pricing**

Item	Oval	Price
253	Small 11 1/2" x 15" Cutout	\$ 1,720
263	Large 13 1/4" x 17 1/4" Cutout	\$ 1,790

**Color Group 3 Pricing**

Item	Oval	Price
253	Small 11 1/2" x 15" Cutout	\$ 2,240
263	Large 13 1/4" x 17 1/4" Cutout	\$ 2,325

**B Glass Color**

All Vitraform glass has color at the edge. None are devoid of color.

**Color Group 1**

Item	Color
C	Clear
S	Starphire®
Z	Bronze
G	Grey
K	Black

**Color Group 2**

Item	Color
P	Peach
A	Azurlite®
X	Solex®

**Color Group 3**

Item	Color
T	Cobalt
B	Blue
L	Cristal
Q	Cristal Antiq

For White color specify Starphire glass in Color Group 1 with White Lami Finish in Column C.

**C Glass Finish**

Item	Finish	Add
P	Polished	\$ 00
F	Frosted <sup>1</sup>	\$ 50
O	White Lami <sup>3,4</sup>	\$ 50
S	Satin Etched <sup>2</sup>	\$ 135
M	Mirror <sup>3</sup>	\$ 365
H	Chalk <sup>3,4</sup>	\$ 180
E	Pearl <sup>3</sup>	\$ 495

1 Frosted finish on bottom surface only.  
 2 Satin Etched finish on inside and outside surface.  
 3 White Lami, Mirror, Chalk or Pearl Finish not available on Black.  
 4 White Lami or Chalk Finish not available on Cobalt.  
**NOTE: FINISHES FOR ENGRAVINGS**  
 Frosted finish recommended for Undermount basins with engraving. For Polished finish contact factory. White Lami, Satin Etched, Mirror, Chalk or Pearl finishes cannot be engraved.  
**NOTE: Engraving on Black, Cobalt and Black & White are not recommended.**



**D Drain Collar**

Drain Collar is required but is NOT included. Order separately. See Drain Collar column at right.

Item	Price
C	Drain Collar

**E With Engraving Add**

See NOTE in column C for available finishes on engraved basins.

Item	Engraving	Small Add	Large Add
00	None	\$ 00	\$ 00
11	Empire	\$ 1,705	\$ 1,920
12	Floral	\$ 1,385	\$ 1,595
13	Victorian	\$ 1,705	\$ 1,920
14	Deco	\$ 1,705	\$ 1,920
15	Tulip	\$ 1,705	\$ 1,920
16	TulipBorder	\$ 1,595	\$ 1,815
17	Traditional	\$ 1,595	\$ 1,815
18	Roman	\$ 1,495	\$ 1,705
20	Moderne	N/A	N/A
25	1960	\$ 1,495	\$ 1,705
26	1930	\$ 2,080	\$ 2,295
28	Fine Lines	\$ 1,545	\$ 1,760
29	Bamboo	\$ 1,545	\$ 1,760
30	Battuto	\$ 2,560	\$ 2,770
31	Confetti	\$ 2,025	\$ 2,240
33	Zebra	\$ 1,545	\$ 1,760
34	Tebori	\$ 2,345	\$ 2,560
36	Arabesque	\$ 2,185	\$ 2,395
38	Palmier	\$ 3,250	\$ 3,460
40	Entre Deux	\$ 1,935	\$ 2,165
43	Eolienne vert.	\$ 2,130	\$ 2,345
44	Eolienne hor.	\$ 2,130	\$ 2,345
45	Emboss	\$ 2,130	\$ 2,345

**Drain Collar**

Required. Order separately. See **Order Example** at lower left of page.

See Metal Finish Codes below.

Item	Price	1	2	3	4
<b>Drain Collar</b>					
900.XX	\$ 50	\$ 50	\$ 55	\$ 60	

**Drain** Optional. Order separately.

See Metal Finish Codes below.

Item	Price	1	2	3	4
<b>Grid Strainer Set</b>					
811.XX w US PTrap	\$ 330	\$ 575	\$ 750	\$ 820	
811.XX.S w Siphon	\$ 455	\$ 670	\$ 855	\$ 920	

**Dome Open Set**

861.XX w US PTrap	\$ 330	\$ 575	\$ 750	\$ 820
861.XX.S w Siphon	\$ 455	\$ 670	\$ 855	\$ 920

**Dome Pop-up Set**

863.XX w US PTrap	\$ 330	\$ 575	\$ 750	\$ 820
863.XX.S w Siphon	\$ 455	\$ 670	\$ 855	\$ 920

**Metal Finish Codes**



1	2	3	4
10 Pol. Chrome	12 Pol. Nickel	15 ORB	13 Pol. Gold*
	20 Sat. Chrome	16 Pol. Brass*	23 Sat. Gold*
	22 Sat. Nickel		

\* Brass and Gold Finishes are PVD.

Order Example	A	B	C	D	E	Engraving Color Upcharge	Select an option in each column A-E including Drain Collar (required) and Drain (optional).
Basin Item No.	253	Z	F	C	15		
Basin Price	\$ 1,490	-	\$ 50	-	\$ 1,705	by Glass Color + \$ 110	Basin Price \$ 3,355
	Small Oval Rimless	Bronze	Frosted	Drain Collar	Tulip Engraving		
Drain Collar Item No.	900	10	Drain Collar / Pol. Chrome Metal Finish (10)			Drain Collar Price	\$ + 50
Drain Item No.	861	10S	Dome Open Set / Siphon / Pol. Chrome Metal Finish (10)			Drain Price	\$ + 455
						<b>Total Price</b>	<b>\$ 3,860</b>

Engraving Color Upcharge	
Upcharges for glass color to be added into price. Does not affect item number.	
Glass Color	Add
Clear, Cristal, Cristal Antiq, Starphire	\$ 00
Bronze, Grey, Peach, Azurlite, Solex, Blue,	\$ 110
NOTE: Engraving on Black or Cobalt are not offered for Rimless Installation. Request assistance.	

Rimless Undermount / Round or Oval With Overflow To order, select an option in each of columns A–E. Order Drain separately. Include Item No. and Price. See Example at bottom of page. Retail Price List

A Select Type of Basin		B Glass Color		C Glass Finish		D Overflow		E Gilded Finish						
Price based on Color Groups.		All Vitraform glass has color at the edge. None are devoid of color.				Overflow required but NOT included. Order separately. See Overflow column at right.		This page is for Gilded Finishes only. 1 These patterns available on Black only. 2 These patterns available on Cristal Antiq only.						
ROUND Basin Size		Round Color Group 1		Item	Finish	Item		Round Group 1	Price	Price				
Item	Round	Item	Color	R	Rose Gold	F	Overflow	Item	Pattern	203	213			
203	Small Round 13" Cutout	K	Black	W	White Gold			GR	Graphique <sup>1</sup>	\$ 4,390	\$ 4,755			
213	Large Round 15" Cutout	S	Starphire® White					FR	Fragment <sup>1</sup>	\$ 2,555	\$ 2,780			
		Black used for Graphique, Fragment, Desir and Envie patterns. Starphire White used for Desir and Envie patterns only.						DE	Desir <sup>2</sup>	\$ 2,625	\$ 2,730			
		Round Color Group 3		Item	Color					Round Group 3	Price	Price		
		Q	Cristal Antiq							VA	Vapeur <sup>2</sup>	\$ 6,050	\$ 6,270	
		Cristal Antique used for Vapeur, Cubiste, Matte and Luster patterns.						CU	Cubiste <sup>2</sup>	\$ 6,050	\$ 6,270			
								MA	Matte <sup>2</sup>	\$ 4,465	\$ 4,715			
								LU	Lustre <sup>2</sup>	\$ 6,365	\$ 6,605			
OVAL Basin Size		Oval Color Group 1		Item	Finish	Item		Oval Group 1	Price	Price				
Item	Oval	Item	Color	R	Rose Gold	F	Overflow	Item	Pattern	253	263			
253	Small Oval 11-1/2" x 15" Cutout	K	Black	W	White Gold			GR	Graphique <sup>1</sup>	\$ 4,685	\$ 5,070			
263	Large Oval 13-1/4" x 17-1/4" Cutout	S	Starphire® White					FR	Fragment <sup>1</sup>	\$ 2,725	\$ 2,965			
		Black used for Graphique, Fragment, Desir and Envie patterns. Starphire White used for Desir and Envie patterns only.						DE	Desir <sup>2</sup>	\$ 2,660	\$ 2,805			
		Round Color Group 3		Item	Color					Oval Group 3	Price	Price		
		Q	Cristal Antiq							VA	Vapeur <sup>2</sup>	\$ 6,175	\$ 6,390	
		Cristal Antique used for Vapeur, Cubiste, Matte and Luster patterns.						CU	Cubiste <sup>2</sup>	\$ 6,175	\$ 6,390			
								MA	Matte <sup>2</sup>	\$ 4,660	\$ 4,905			
								LU	Lustre <sup>2</sup>	\$ 6,525	\$ 6,765			

Overflow				
Required. Order separately. See <b>Order Example</b> at lower left of page.				
See Metal Finish Codes below.				
Item	Price			
Overflow	1	2	3	4
911.XX Small Round	\$ 255	\$ 255	\$ 260	\$ 285
912.XX Large Round	\$ 255	\$ 255	\$ 260	\$ 285
916.XX Small Oval	\$ 255	\$ 255	\$ 260	\$ 285
917.XX Large Oval	\$ 255	\$ 255	\$ 260	\$ 285
Drain Optional. Order separately.				
See Metal Finish Codes below.				
Item	Price			
Grid Strainer Set	1	2	3	4
810.XX w US PTrap	\$ 330	\$ 575	\$ 750	\$ 820
810.XX.S w Siphon	\$ 455	\$ 670	\$ 855	\$ 920
Dome Open Set				
860.XX w US PTrap	\$ 330	\$ 575	\$ 750	\$ 820
860.XX.S w Siphon	\$ 455	\$ 670	\$ 855	\$ 920
Dome Pop-up Set				
862.XX w US PTrap	\$ 330	\$ 575	\$ 750	\$ 820
862.XX.S w Siphon	\$ 455	\$ 670	\$ 855	\$ 920
Metal Finish Codes				
1	2	3	4	
10 Pol. Chrome	12 Pol. Nickel 20 Sat. Chrome 22 Sat. Nickel	15 ORB 16 Pol. Brass*	13 Pol. Gold* 23 Sat. Gold*	
* Brass and Gold Finishes are PVD.				

Order Example	A	B	C	D	E	Engraving Color Upcharge	Select an option in each column A-E including Overflow (required) and Drain (optional).
Basin Item No.	203	K	R	F	GR		
Basin Price	-	-	-	-	\$ 4,390	NA	Basin Price \$ 4,390
Sm. Round Rimless      Rose Gold      Graphique Pattern Black      Overflow							
Overflow Item No.	911	13	Lg Round Overflow / Pol. Gold Metal Finish (13)			Overflow Price	\$ + 285
Drain Item No.	810	13	Dome Open Set / Overflow / US PTrap / Pol. Gold Metal Finish (13)			Drain Price	\$ + 820
						<b>Total Price</b>	<b>\$ 5,495</b>



Rimless Undermount / Round or Oval Without Overflow To order, select an option in each of columns A-E. Order Drain separately. Include Item No. and Price. See Example at bottom of page. Retail Price List

A Select Type of Basin		B Glass Color		C Glass Finish		D Drain Collar		E Gilded Finish				
Price based on Color Groups.		All Vitraform glass has color at the edge. None are devoid of color.				Drain Collar is required but is NOT included. Order separately. See Drain Collar column at right.		This page is for Gilded Finishes only.				
ROUND Basin Size		Round Color Group 1		Item	Finish	Item		Round Group 1	Price	Price		
Item	Round	Item	Color	R	Rose Gold	C	Drain Collar	Item	Pattern	203	213	
203	Small Round 13" Cutout	K	Black	W	White Gold			GR	Graphique <sup>1</sup>	\$ 4,390	\$ 4,755	
213	Large Round 15" Cutout	S	Starphire® White					FR	Fragment <sup>1</sup>	\$ 2,555	\$ 2,780	
		Black used for Graphique, Fragment, Desir and Envie patterns. Starphire White used for Desir and Envie patterns only.						DE	Desir <sup>2</sup>	\$ 2,625	\$ 2,730	
		Round Color Group 3						EN	Envie <sup>2</sup>	\$ 2,625	\$ 2,730	
		Item	Color					Round Group 3	Price	Price		
		Q	Cristal Antiq					Item	Pattern	203	213	
		Cristal Antique used for Vapeur, Cubiste, Matte and Luster patterns.						VA	Vapeur <sup>2</sup>	\$ 6,050	\$ 6,270	
								CU	Cubiste <sup>2</sup>	\$ 6,050	\$ 6,270	
								MA	Matte <sup>2</sup>	\$ 4,465	\$ 4,715	
								LU	Lustre <sup>2</sup>	\$ 6,365	\$ 6,605	

Drain Collar				
Required. Order separately. See Order Example at lower left of page.				
See Metal Finish Codes below.				
Item	Price			
Drain Collar	1	2	3	4
900.XX	\$ 50	\$ 50	\$ 55	\$ 60
Drain Optional. Order separately.				
See Metal Finish Codes below.				
Item	Price			
Grid Strainer Set	1	2	3	4
811.XX w US PTrap	\$ 330	\$ 575	\$ 750	\$ 820
811.XX.S w Siphon	\$ 455	\$ 670	\$ 855	\$ 920
Dome Open Set				
861.XX w US PTrap	\$ 330	\$ 575	\$ 750	\$ 820
861.XX.S w Siphon	\$ 455	\$ 670	\$ 855	\$ 920
Dome Pop-up Set				
863.XX w US PTrap	\$ 330	\$ 575	\$ 750	\$ 820
863.XX.S w Siphon	\$ 455	\$ 670	\$ 855	\$ 920
Metal Finish Codes				
1	2	3	4	
10 Pol. Chrome	12 Pol. Nickel 20 Sat. Chrome 22 Sat. Nickel	15 ORB 16 Pol. Brass*	13 Pol. Gold* 23 Sat. Gold*	
* Brass and Gold Finishes are PVD.				

OVAL Basin Size		Oval Color Group 1		Item	Finish	Item		Oval Group 1	Price	Price		
Item	Oval	Item	Color	R	Rose Gold	C	Drain Collar	Item	Pattern	253	263	
253	Small Oval 11-1/2" x 15" Cutout	K	Black	W	White Gold			GR	Graphique <sup>1</sup>	\$ 4,685	\$ 5,070	
263	Large Oval 13-1/4" x 17-1/4" Cutout	S	Starphire® White					FR	Fragment <sup>1</sup>	\$ 2,725	\$ 2,965	
		Black used for Graphique, Fragment, Desir and Envie patterns. Starphire White used for Desir and Envie patterns only.						DE	Desir <sup>2</sup>	\$ 2,660	\$ 2,805	
		Round Color Group 3						EN	Envie <sup>2</sup>	\$ 2,660	\$ 2,805	
		Item	Color					Oval Group 3	Price	Price		
		Q	Cristal Antiq					Item	Pattern	253	263	
		Cristal Antique used for Vapeur, Cubiste, Matte and Luster patterns.						VA	Vapeur <sup>2</sup>	\$ 6,175	\$ 6,390	
								CU	Cubiste <sup>2</sup>	\$ 6,175	\$ 6,390	
								MA	Matte <sup>2</sup>	\$ 4,660	\$ 4,905	
								LU	Lustre <sup>2</sup>	\$ 6,525	\$ 6,765	

Order Example	A	B	C	D	E	Engraving Color Upcharge	Select an option in each column A-E including Drain Collar (required) and Drain (optional).
Basin Item No.	263	Q	R	C	MA		
Basin Price	-	-	-	-	\$ 4,905	NA	Basin Price \$ 4,905
Lrg. Oval Rimless      Rose Gold      Matte Pattern Cristal Antiq      Drain Collar							
Drain Collar Item No.	900	10	Drain Collar / Pol. Chrome Metal Finish (10)			Drain Collar Price	\$ + 50
Drain Item No.	861	10S	Dome Open Set / Siphon / Pol. Chrome Metal Finish (10)			Drain Price	\$ + 455
						Total Price	\$ 5,410





Freestanding Basin



Freestanding ADA Large Round Basin in Cristal Antique.  
Shown with matching Countertop.



Round Freestanding Basin in Starphire Mirror with Entre Deux Engraving.  
Shown with Countertop in Starphire Mirror.



Freestanding Basin / Round To order, select an option in each of columns A-F. Order Drain separately. Include Item No. and Price. See Example at bottom of page.

Retail Price List

A Select Type of Basin			B Glass Color		C Glass Finish			D No Overflow		E With Engraving or Perla Add				F Base Mount Metal Finish		
Price based on Color Groups.			All Vitraform glass has color at the edge. None are devoid of color.					Not available with overflow.		Refer to NOTE in column C for available finishes on engraved and PERLA basins.						
Color Group 1 Pricing			Color Group 1							Small		Large				
Item	Round	Price	Item	Color	Item	Finish	Add	Item		Item	Engraving	Add	Add	Item	Finish	Add
200	Small 14 5/8"	\$ 1,980	C	Clear	P	Polished	\$ 00	N	No hole	00	None	\$ 00	\$ 00	10	Pol. Chrome	\$ 00
210	Large 16 3/4"	\$ 2,050	S	Starphire®	F	Frosted <sup>1</sup>	\$ 50			11	Empire	\$ 1,500	\$ 1,705	12	Pol. Nickel	\$ 00
214	ADA 16 3/4"	\$ 2,050	Z	Bronze	O	White Lami <sup>3,4</sup>	\$ 50			12	Floral	\$ 1,175	\$ 1,385	20	Sat. Chrome	\$ 00
230	Pencil Edge 17 1/2"	\$ 2,050	G	Grey	S	Satin Etched <sup>2</sup>	\$ 135			13	Victorian	\$ 1,500	\$ 1,705	22	Sat. Nickel	\$ 00
			K	Black	M	Mirror <sup>3</sup>	\$ 365			14	Deco	\$ 1,500	\$ 1,705	15	ORB	\$ 105
Color Group 2 Pricing			Color Group 2		1 Frosted finish on bottom surface only. 2 Satin Etched finish on top and bottom surface. 3 White Lami, Mirror, Chalk or Pearl Finish not available on Black. 4 White Lami or Chalk Finish not available on Cobalt. NOTE: FINISHES FOR ENGRAVED AND PERLA BASINS: Freestanding basins may be engraved with Polished or Mirror finishes. For Frosted finish contact factory. White Lami, Satin Etched, Mirror, Chalk or Pearl finishes cannot be engraved. PERLA not available with Frosted or Satin Etched finishes.					15	Tulip	\$ 1,500	\$ 1,705	16	PVD Pol. Brass	\$ 105
Item	Round	Price	Item	Color						16	Tulip Border	\$ 1,385	\$ 1,595	13	PVD Pol. Gold	\$ 175
200	Small 14 5/8"	\$ 2,210	P	Peach						17	Traditional	\$ 1,385	\$ 1,595	23	PVD Sat. Gold	\$ 175
210	Large 16 3/4"	\$ 2,285	A	Azurlite®						18	Roman	\$ 1,285	\$ 1,495			
214	ADA 16 3/4"	\$ 2,285	X	Solex®						20	Moderne	\$ 1,500	\$ 1,705			
230	Pencil Edge 17 1/2"	\$ 2,285								25	1960 <sup>2</sup>	\$ 1,285	\$ 1,495			
Color Group 3 Pricing			Color Group 3							26	1930 <sup>2</sup>	\$ 1,868	\$ 2,080			
Item	Round	Price	Item	Color						28	Fine Lines <sup>2</sup>	\$ 1,330	\$ 1,545			
200	Small 14 5/8"	\$ 2,990	T	Cobalt						29	Bamboo <sup>2</sup>	\$ 1,330	\$ 1,545			
210	Large 16 3/4"	\$ 3,075	B	Blue						30	Battuto <sup>2</sup>	\$ 2,345	\$ 2,560			
214	ADA 16 3/4"	\$ 3,075	L	Cristal						31	Confetti <sup>2</sup>	\$ 1,810	\$ 2,025			
230	Pencil Edge 17 1/2"	\$ 3,075	Q	Cristal Antiq						33	Zebra <sup>2</sup>	\$ 1,330	\$ 1,545			
										34	Tebori <sup>2</sup>	\$ 2,130	\$ 2,345			
			For White color specify Starphire glass in Color Group 1 with White Lami Finish in Column C.							36	Arabesque <sup>2</sup>	\$ 1,970	\$ 2,185			
										38	Palmier <sup>2</sup>	\$ 3,035	\$ 3,250			
										40	Entre Deux <sup>2</sup>	\$ 1,700	\$ 1,935			
										43	Eolienne vert. <sup>2</sup>	\$ 1,915	\$ 2,130			
										44	Eolienne hor. <sup>2</sup>	\$ 1,915	\$ 2,130			
										45	Emboss	\$ 1,915	\$ 2,130			
										CC	PERLA	\$ 1,765	\$ 1,950			



Order Example	A	B	C	D	E	F	Engraving Color Upcharge	Select an option in each column A-F and Drain (optional).		
Basin Item No.	210	A	P	N	20	12		Basin Price	\$ 4,100	
Basin Price	\$ 2,285	-	\$ 00	-	\$ 1,705	\$ 00	by Glass Color + 110	Basin Price	\$ 4,100	
	Lrg. Round Freestnd.	Azurlite	Polished	No Overflow	Moderne Engraving	Pol. Nickel Base Finish				
Drain Item No.	861	10S	Dome Drain Set / Siphon / Pol. Nickel Metal Finish (12)				Drain Price	\$ + 670		
							Total Price	\$ 4,770		

Engraving Color Upcharge	
Add upcharge for glass color on engravings only, not Perla. Does not affect item number.	
Glass Color	Add
Clear, Cristal, Cristal Antiq, Starphire	\$ 00
Bronze, Grey, Peach, Azurlite, Solex, Blue,	\$ 110
Black, Cobalt	\$ 565

Drain Optional. Order separately.							
See Metal Finish Codes below.							
Item		Price					
Grid Strainer Set		1	2	3	4		
811.XX	w US PTrap	\$ 330	\$ 575	\$ 750	\$ 820		
811.XX.S	w Siphon	\$ 455	\$ 670	\$ 855	\$ 920		
Dome Open Set							
861.XX	w US PTrap	\$ 330	\$ 575	\$ 750	\$ 820		
861.XX.S	w Siphon	\$ 455	\$ 670	\$ 855	\$ 920		
Dome Pop-up Set							
863.XX	w US PTrap	\$ 330	\$ 575	\$ 750	\$ 820		
863.XX.S	w Siphon	\$ 455	\$ 670	\$ 855	\$ 920		
Metal Finish Codes							
1		2		3		4	
10 Pol. Chrome	12 Pol. Nickel	15 ORB	13 Pol. Gold*	20 Sat. Chrome	16 Pol. Brass*	23 Sat. Gold*	
	22 Sat. Nickel						

\* Brass and Gold Finishes are PVD.

## Freestanding Basin / Oval

To order, select an option in each of columns A-F. Order Drain separately. Include Item No. and Price. See Example at bottom of page.

Retail Price List

A Select Type of Basin			B Glass Color		C Glass Finish			D No Overflow		E With Engraving or Perla Add				F Base Mount Metal Finish					
Price based on Color Groups.			All Vitraform glass has color at the edge. None are devoid of color.					Not available with overflow.		Refer to NOTE in column C for available finishes on engraved and PERLA basins.									
Color Group 1 Pricing			Color Group 1																
Item	Oval	Price	Item	Color	Item	Finish	Add	Item		Item	Engraving	Small Add	Large Add	Item	Finish	Add			
250	Small 13" x 17"	\$ 1,980	C	Clear	P	Polished	\$ 00	N	No hole	00	None	\$ 00	\$ 00	10	Pol. Chrome	\$ 00			
260	Large 15" x 19"	\$ 2,050	S	Starphire®	F	Frosted <sup>1</sup>	\$ 50										12	Pol. Nickel	\$ 00
264	ADA 15" x 19"	\$ 2,050	Z	Bronze	O	White Lami <sup>3,4</sup>	\$ 50										20	Sat. Chrome	\$ 00
			G	Grey	S	Satin Etched <sup>2</sup>	\$ 135										22	Sat. Nickel	\$ 00
			K	Black	M	Mirror <sup>3</sup>	\$ 365										15	ORB	\$ 105
Color Group 2 Pricing			Color Group 2		H	Chalk <sup>3,4</sup>	\$ 180										16	PVD Pol. Brass	\$ 105
Item	Oval	Price	Item	Color	E	Pearl <sup>3</sup>	\$ 495										13	PVD Pol. Gold	\$ 175
250	Small 13" x 17"	\$ 2,210	P	Peach	<sup>1</sup> Frosted finish on bottom surface only. <sup>2</sup> Satin Etched finish on top and bottom surface. <sup>3</sup> White Lami, Mirror, Chalk or Pearl Finish not available on Black. <sup>4</sup> White Lami or Chalk Finish not available on Cobalt. NOTE: FINISHES FOR ENGRAVED AND PERLA BASINS: Freestanding basins may be engraved with Polished or Mirror finishes. For Frosted finish contact factory. White Lami, Satin Etched, Mirror, Chalk or Pearl finishes cannot be engraved. PERLA not available with Frosted or Satin Etched finishes.												23	PVD Sat. Gold	\$ 175
260	Large 15" x 19"	\$ 2,285	A	Azurlite®															
264	ADA 15" x 19"	\$ 2,285	X	Solex®															
Color Group 3 Pricing			Color Group 3																
Item	Oval	Price	Item	Color															
250	Small 13" x 17"	\$ 2,990	T	Cobalt															
260	Large 15" x 19"	\$ 3,075	B	Blue															
264	ADA 15" x 19"	\$ 3,075	L	Cristal															
			Q	Cristal Antiq															
			For White color specify Starphire glass in Color Group 1 with White Lami Finish in Column C.																



Order Example	A	B	C	D	E	F	Engraving Color Upcharge	Select an option in each column A-F and Drain (optional).
Basin Item No.	250	X	P	N	34	22		
Basin Price	\$ 2,210	-	\$ 00	-	\$ 2,345	\$ 00	by Glass Color + \$110	Basin Price \$ 4,665
Small Oval Freestnd.		Polished		Tebori Engraving				
Solex		No Overflow		Satin Nickel Base Finish				
Drain Item No.	861	22S	Dome Drain Set / Siphon / Satin Nickel Metal Finish (22)				Drain Price	\$ + 670
							Total Price	\$ 5,335

Engraving Color Upcharge	
Add upcharge for glass color on engravings only, not Perla. Does not affect item number.	
Glass Color	Add
Clear, Cristal, Cristal Antiq, Starphire	\$ 00
Bronze, Grey, Peach, Azurlite, Solex, Blue	\$ 110
Black, Cobalt	\$ 565

Drain Optional. Order separately.				
See Metal Finish Codes below.				
Item	Price			
	1	2	3	4
<b>Grid Strainer Set</b>				
811.XX w US PTrap	\$ 330	\$ 575	\$ 750	\$ 820
811.XX.S w Siphon	\$ 455	\$ 670	\$ 855	\$ 920
<b>Dome Open Set</b>				
861.XX w US PTrap	\$ 330	\$ 575	\$ 750	\$ 820
861.XX.S w Siphon	\$ 455	\$ 670	\$ 855	\$ 920
<b>Dome Pop-up Set</b>				
863.XX w US PTrap	\$ 330	\$ 575	\$ 750	\$ 820
863.XX.S w Siphon	\$ 455	\$ 670	\$ 855	\$ 920
Metal Finish Codes				
1	2	3	4	
10 Pol. Chrome	12 Pol. Nickel	15 ORB	13 Pol. Gold*	
	20 Sat. Chrome	16 Pol. Brass*	23 Sat. Gold*	
	22 Sat. Nickel			
* Brass and Gold Finishes are PVD.				

Freestanding Basin / Round To order, select an option in each of columns A-F. Order Drain separately. Include Item No. and Price. See Example at bottom of page.

Retail Price List

A Select Type of Basin	
Price based on Color Groups.	
Basin Size	
Item	Round
200	Small 14 5/8"
210	Large 16 3/4"
214	Large ADA 16 3/4"
230	Large Pencil Edge 17 1/2"

B Glass Color	
All Vitraform glass has color at the edge. None are devoid of color.	
Color Group 1	
Item	Color
K	Black
S	Starphire® White
Black used for Graphique, Fragment, Desir and Envie patterns. White used for Desir and Envie patterns only.	
Color Group 3	
Item	Color
Q	Cristal Antiq
Cristal Antique used for Vapeur, Cubiste, Matte and Luster patterns.	

C Glass Finish	
Item	Finish
R	Rose Gold
W	White Gold

D No Overflow	
Not available with overflow.	
Item	
N	No hole

E Gilded Finish			
This page is for Gilded Finishes only.			
Color Group 1		Price	Price
Item	Pattern	200	210, 230, 214
GR	Graphique <sup>1</sup>	\$ 4,870	\$ 5,230
FR	Fragment <sup>1</sup>	\$ 3,055	\$ 3,265
DE	Desir <sup>2</sup>	\$ 2,930	\$ 3,030
EN	Envie <sup>2</sup>	\$ 2,930	\$ 3,030
<sup>1</sup> These patterns available on Black glass only. <sup>2</sup> These patterns available on Starphire glass with black or white lamination. Additional glass color and/or finish by request.			
Color Group 3		Price	Price
Item	Pattern	200	210, 230, 214
VA	Vapeur <sup>2</sup>	\$ 6,765	\$ 7,010
CU	Cubiste <sup>2</sup>	\$ 6,765	\$ 7,010
MA	Matte <sup>2</sup>	\$ 5,205	\$ 5,445
LU	Lustre <sup>2</sup>	\$ 7,140	\$ 7,380
<sup>2</sup> These patterns available on Cristal Antique glass only.			

F Base Mount Metal Finish		
Item	Finish	Add
10	Pol. Chrome	\$ 00
12	Pol. Nickel	\$ 00
20	Sat. Chrome	\$ 00
22	Sat. Nickel	\$ 00
15	ORB	\$ 105
16	PVD Pol. Brass	\$ 105
13	PVD Pol. Gold	\$ 175
23	PVD Sat. Gold	\$ 175



Drain Optional. Order separately.					
See Metal Finish Codes below.					
Item		Price			
Grid Strainer Set		1	2	3	4
811.XX	w US PTrap	\$ 330	\$ 575	\$ 750	\$ 820
811.XX.S	w Siphon	\$ 455	\$ 670	\$ 855	\$ 920
Dome Open Set					
861.XX	w US PTrap	\$ 330	\$ 575	\$ 750	\$ 820
861.XX.S	w Siphon	\$ 455	\$ 670	\$ 855	\$ 920
Dome Pop-up Set					
863.XX	w US PTrap	\$ 330	\$ 575	\$ 750	\$ 820
863.XX.S	w Siphon	\$ 455	\$ 670	\$ 855	\$ 920
Metal Finish Codes					
1	2	3	4		
10 Pol. Chrome	12 Pol. Nickel 20 Sat. Chrome 22 Sat. Nickel	15 ORB 16 Pol. Brass*	13 Pol. Gold* 23 Sat. Gold*		
* Brass and Gold Finishes are PVD.					

Order Example	A	B	C	D	E	F	Engraving Color Upcharge	Select an option in each column A-F and Drain (optional).
Basin Item No.	210	Q	R	N	VA	12	NA	Basin Price \$ 7,010
Basin Price	-	-	-	-	\$ 7,010	\$ 00	NA	Basin Price \$ 7,010
Lg. Round Freestnd.    Rose Gold    Vapeur Gilded Pattern								
Cristal Antiq    No Overflow    Pol. Nickel Base Finish								
Drain Item No.	861	12S	Dome Drain Set / Siphon / Pol. Nickel Metal Finish (12)					Drain Price \$ + 670
								Total Price \$ 7,680



### Freestanding Basin / Oval

To order, select an option in each of columns A-F. Order Drain separately. Include Item No. and Price. See Example at bottom of page.

Retail Price List

A Select Type of Basin	
Price based on Color Groups.	
Basin Size	
Item	Oval
250	Small 13 x 17"
260	Large 15 x 19"
264	Large ADA 15 x 19"

B Glass Color	
All Vitraform glass has color at the edge. None are devoid of color.	
Color Group 1	
Item	Color
K	Black
S	Starphire® White
Black used for Graphique, Fragment, Desir and Envie patterns. White used for Desir and Envie patterns only.	
Color Group 3	
Item	Color
Q	Cristal Antiq
Cristal Antique used for Vapeur, Cubiste, Matte and Luster patterns.	

C Glass Finish	
Item	Finish
R	Rose Gold
W	White Gold

D No Overflow	
Not available with overflow.	
Item	
N	No hole

E Gilded Finish			
This page is for Gilded Finishes only.			
Color Group 1		Price	Price
Item	Pattern	250	260, 264
GR	Graphique <sup>1</sup>	\$ 5,175	\$ 5,555
FR	Fragment <sup>1</sup>	\$ 3,210	\$ 3,415
DE	Desir <sup>2</sup>	\$ 2,965	\$ 3,110
EN	Envie <sup>2</sup>	\$ 2,965	\$ 3,110
<sup>1</sup> These patterns available on Black glass only. <sup>2</sup> These patterns available on Starphire glass with black or white lamination. Additional glass color and/or finish by request.			
Color Group 3		Price	Price
Item	Pattern	250	260, 264
VA	Vapeur <sup>2</sup>	\$ 6,885	\$ 7,130
CU	Cubiste <sup>2</sup>	\$ 6,885	\$ 7,130
MA	Matte <sup>2</sup>	\$ 5,445	\$ 5,630
LU	Lustre <sup>2</sup>	\$ 7,295	\$ 7,500
<sup>2</sup> These patterns available on Cristal Antique glass only.			

F Base Mount Metal Finish		
Item	Finish	Add
10	Pol. Chrome	\$ 00
12	Pol. Nickel	\$ 00
20	Sat. Chrome	\$ 00
22	Sat. Nickel	\$ 00
15	ORB	\$ 105
16	PVD Pol. Brass	\$ 105
13	PVD Pol. Gold	\$ 175
23	PVD Sat. Gold	\$ 175



Drain Optional. Order separately.					
See Metal Finish Codes below.					
Item		Price			
Grid Strainer Set		1	2	3	4
811.XX	w US PTrap	\$ 330	\$ 575	\$ 750	\$ 820
811.XX.S	w Siphon	\$ 455	\$ 670	\$ 855	\$ 920
Dome Open Set					
861.XX	w US PTrap	\$ 330	\$ 575	\$ 750	\$ 820
861.XX.S	w Siphon	\$ 455	\$ 670	\$ 855	\$ 920
Dome Pop-up Set					
863.XX	w US PTrap	\$ 330	\$ 575	\$ 750	\$ 820
863.XX.S	w Siphon	\$ 455	\$ 670	\$ 855	\$ 920
Metal Finish Codes					
1	2	3	4		
10 Pol. Chrome	12 Pol. Nickel 20 Sat. Chrome 22 Sat. Nickel	15 ORB 16 Pol. Brass*	13 Pol. Gold* 23 Sat. Gold*		
* Brass and Gold Finishes are PVD.					

Order Example	A	B	C	D	E	F	Engraving Color Upcharge	Select an option in each column A-F and Drain (optional).	
Basin Item No.	260	K	W	N	FR	22			
Basin Price	-	-	-	-	\$ 3,415	\$ 00	NA	Basin Price \$ 3,415	
Lg. Oval Freestnd.      White Gold      Fragment Pattern Black      No Overflow      Sat. Nickel Base Finish									
Drain Item No.	811	22S	Dome Drain Set / Siphon / Sat. Nickel Metal Finish (22)					Drain Price	\$ + 670
								Total Price \$ 4,085	



Freestanding Basin / Rectangular **NEW Product** To order, select an option in each of columns A–F. Order Drain separately. Include Item No. and Price. See Example at bottom of page. Retail Price List

A Select Type of Basin			B Glass Color		C Glass Finish			D No Overflow		E With Engraving Add				F Base Mount Metal Finish					
Price based on Color Groups.			All Vitraform glass has color at the edge. None are devoid of color.					Not available with overflow.		Engraving not available on 235 or 240 Basin.									
Color Group 1 Pricing			Color Group 1																
Item	Rectangular	Price	Item	Color	Item	Finish	Add	Item		Item	Engraving	Add	Add	Item	Finish	Add			
235	Small 12 1/4 x 15 1/4"	\$ 1,980	C	Clear	P	Polished	\$ 00	N	No hole	00	None	\$ 00	\$ 00	10	Pol. Chrome	\$ 00			
240	Large 16 x 21"	\$ 2,050	S	Starphire®	F	Frosted <sup>1</sup>	\$ 50										12	Pol. Nickel	\$ 00
			Z	Bronze	O	White Lami <sup>3,4</sup>	\$ 50										20	Sat. Chrome	\$ 00
			G	Grey	S	Satin Etched <sup>2</sup>	\$ 135										22	Sat. Nickel	\$ 00
			K	Black	M	Mirror <sup>3</sup>	\$ 365										15	ORB	\$ 105
Color Group 2 Pricing			Color Group 2																
Item	Rectangular	Price	Item	Color	<th colspan="2"> <th colspan="4"> <th colspan="3"> </th></th></th>			<th colspan="4"> <th colspan="3"> </th></th>		<th colspan="3"> </th>									
235	Small 12 1/4 x 15 1/4"	\$ 2,210	P	Peach															
240	Large 16 x 21"	\$ 2,285	A	Azurlite®															
			X	Solex®															
Color Group 3 Pricing			Color Group 3																
Item	Rectangular	Price	Item	Color	1 Frosted finish on bottom surface only. 2 Satin Etched finish on top and bottom surface. 3 White Lami, Mirror, Chalk or Pearl Finish not available on Black. 4 White Lami or Chalk Finish not available on Cobalt. NOTE: FINISHES FOR ENGRAVED AND PERLA BASINS: Freestanding basins may be engraved with Polished or Mirror finishes. For Frosted finish contact factory. White Lami, Satin Etched, Mirror, Chalk or Pearl finishes cannot be engraved. PERLA not available with Frosted or Satin Etched finishes.														
235	Small 12 1/4 x 15 1/4"	\$ 2,990	T	Cobalt															
240	Large 16 x 21"	\$ 3,075	B	Blue															
			L	Cristal															
			Q	Cristal Antiq															
			For White color specify Starphire glass in Color Group 1 with White Lami Finish in Column C.																



Drain Optional. Order separately.					
See Metal Finish Codes below.					
Item		Price			
Grid Strainer Set		1	2	3	4
811.XX	w US PTrap	\$ 330	\$ 575	\$ 750	\$ 820
811.XX.S	w Siphon	\$ 455	\$ 670	\$ 855	\$ 920
Dome Open Set					
861.XX	w US PTrap	\$ 330	\$ 575	\$ 750	\$ 820
861.XX.S	w Siphon	\$ 455	\$ 670	\$ 855	\$ 920
Dome Pop-up Set					
863.XX	w US PTrap	\$ 330	\$ 575	\$ 750	\$ 820
863.XX.S	w Siphon	\$ 455	\$ 670	\$ 855	\$ 920
Metal Finish Codes					
	1	2	3	4	
10 Pol. Chrome	12 Pol. Nickel	15 ORB	13 Pol. Gold*		
	20 Sat. Chrome	16 Pol. Brass*	23 Sat. Gold*		
	22 Sat. Nickel				

\* Brass and Gold Finishes are PVD.

Order Example	A	B	C	D	E	F		
Basin Item No.	235	A	P	N	00	12	Select an option in each column A-F and Drain (optional).	
Basin Price	\$ 2,210	-	\$ 00	-	\$ 00	\$ 00	Basin Price \$ 2,210	
Small Rect. Freestanding   Polished   Engraving NA Azurlite   No Overflow   Pol. Nickel Base Finish								
Drain Item No.	861	10S	Dome Drain Set / Siphon / Pol. Nickel Metal Finish (12)				Drain Price	\$ + 670
							Total Price	\$ 2,880

Freestanding Basin / Rectangular **NEW Product** To order, select an option in each of columns A–F. Order Drain separately. Include Item No. and Price. See Example at bottom of page. Retail Price List

A Select Type of Basin	
Price based on Color Groups.	
Basin Size	
Item	Rectangular
235	Small 12 1/4 x 15 1/4"
240	Large 16 x 21"

B Glass Color	
All Vitraform glass has color at the edge. None are devoid of color.	
Color Group 1	
Item	Color
K	Black
S	Starphire® White
Black used for Graphique, Fragment, Desir and Envie patterns. White used for Desir and Envie patterns only.	
Color Group 3	
Item	Color
Q	Cristal Antiq
Cristal Antique used for Vapeur, Cubiste, Matte and Luster patterns.	

C Glass Finish	
Item	Finish
R	Rose Gold
W	White Gold

D No Overflow	
Not available with overflow.	
Item	
N	No hole

E Gilded Finish			
This page is for Gilded Finishes only.			
Color Group 1		Price	Price
Item	Pattern	235	240
GR	Graphique <sup>1</sup>	\$ 5,175	\$ 5,555
FR	Fragment <sup>1</sup>	\$ 3,210	\$ 3,415
DE	Desir <sup>2</sup>	\$ 2,965	\$ 3,110
EN	Envie <sup>2</sup>	\$ 2,965	\$ 3,110
<sup>1</sup> These patterns available on Black glass only. <sup>2</sup> These patterns available on Starphire glass with black or white lamination. Additional glass color and/or finish by request.			
Color Group 3		Price	Price
Item	Pattern	235	240
VA	Vapeur <sup>2</sup>	\$ 6,885	\$ 7,130
CU	Cubiste <sup>2</sup>	\$ 6,885	\$ 7,130
MA	Matte <sup>2</sup>	\$ 5,445	\$ 5,630
LU	Lustre <sup>2</sup>	\$ 7,295	\$ 7,500
<sup>2</sup> These patterns available on Cristal Antique glass only.			

F Base Mount Metal Finish		
Item	Finish	Add
10	Pol. Chrome	\$ 00
12	Pol. Nickel	\$ 00
20	Sat. Chrome	\$ 00
22	Sat. Nickel	\$ 00
15	ORB	\$ 105
16	PVD Pol. Brass	\$ 105
13	PVD Pol. Gold	\$ 175
23	PVD Sat. Gold	\$ 175



Drain Optional. Order separately.					
See Metal Finish Codes below.					
Item		Price			
Grid Strainer Set		1	2	3	4
811.XX	w US PTrap	\$ 330	\$ 575	\$ 750	\$ 820
811.XX.S	w Siphon	\$ 455	\$ 670	\$ 855	\$ 920
Dome Open Set					
861.XX	w US PTrap	\$ 330	\$ 575	\$ 750	\$ 820
861.XX.S	w Siphon	\$ 455	\$ 670	\$ 855	\$ 920
Dome Pop-up Set					
863.XX	w US PTrap	\$ 330	\$ 575	\$ 750	\$ 820
863.XX.S	w Siphon	\$ 455	\$ 670	\$ 855	\$ 920
Metal Finish Codes					
1	2	3	4		
10 Pol. Chrome	12 Pol. Nickel 20 Sat. Chrome 22 Sat. Nickel	15 ORB 16 Pol. Brass*	13 Pol. Gold* 23 Sat. Gold*		
* Brass and Gold Finishes are PVD.					

Order Example	A	B	C	D	E	F	Engraving Color Upcharge	Select an option in each column A-F and Drain (optional).	
Basin Item No.	240	Q	R	N	VA	12	NA	Basin Price \$ 7,130	
Basin Price	-	-	-	-	\$ 7,130	\$ 00	NA	Basin Price \$ 7,130	
Lg. Rect. Freestanding    Rose Gold    Vapeur Gilded Pattern Cristal Antiq    No Overflow    Pol. Nickel Base Finish									
Drain Item No.	861	12S	Dome Drain Set / Siphon / Pol. Nickel Metal Finish (12)					Drain Price \$ + 670	
							Total Price \$ 7,800		





## Countersink



Countersink with Rectangular Basins in Starphire Chalk.

Shown on GN2 Vanity in Walnut with LED under cabinet lighting. Under cabinet lighting is not provided.



Countersink with Rectangular Basin in Starphire White Lami.

Countersink / Round or Oval Basin With Overflow To order, select an option in each of columns A–E. Order overflow and Drain separately. Include Item No. and Price. See Example at bottom of page. Retail Price List

**A Specify Model**

Single Basin	
Item	Description
<b>Rectangular Front</b>	
300	Single Round Basin
350	Single Oval Basin
<b>Radius front</b>	
400	Single Round Basin
450	Single Oval Basin
<b>Double Basin</b>	
Rectangular Front	
302	Double Round Basin
352	Double Oval Basin
<b>Radius front</b>	
402	Double Round Basin
452	Double Oval Basin
<b>Triple Basin</b>	
Rectangular Front	
303	Triple Round Basin
353	Triple Oval Basin
<b>Radius front</b>	
403	Triple Round Basin
453	Triple Oval Basin

**B Glass Color**

All Vitraform glass has color at the edge. None are devoid of color.

Color Group 1	
Item	Color
C	Clear
S	Starphire®
Z	Bronze
G	Grey
K	Black
Color Group 2	
P	Peach
A	Azurlite®
X	Solex®
Color Group 3	
T	Cobalt
B	Blue

For White color specify Starphire glass in Color Group 1 with White Lami Finish in Column C.

**C Glass Finish**

1 Frosted finish on bottom surface only.  
2 Satin Etched finish on top and bottom surface.  
3 White Lami, Mirror, Chalk or Pearl not available on Black.  
4 White Lami or Chalk not available on Cobalt.

Item	Finish	Add
P	Polished	\$ 00
F	Frosted <sup>1</sup>	
	24"-36" width	\$ 195
	37"-60" width	\$ 235
	61"-84" width	\$ 295
O	White Lami <sup>3,4</sup>	
	24"-36" width	\$ 195
	37"-60" width	\$ 235
	61"-84" width	\$ 295
S	Satin Etched <sup>2</sup>	
	24"-36" width	\$ 385
	37"-60" width	\$ 470
	61"-84" width	\$ 595
M	Mirror <sup>3</sup>	
	24"-36" width	\$ 725
	37"-60" width	\$ 1,090
H	Chalk <sup>3,4</sup>	
	24"-36" width	\$ 580
	37"-60" width	\$ 710
	61"-84" width	\$ 890
E	Pearl <sup>3</sup>	
	24"-36" width	\$ 1,115
	37"-60" width	\$ 1,560
	61"-84" width	\$ 2,120

**D Overflow**

Overflow required but NOT included. Order separately. See Overflow column at right.

Item	Description
F	Overflow

**E Specify Width**

Priced in 6" increments. Drawings provided by Vitraform to exact dimension required.

Single Basin by Color Group			
Item	Group 1	Group 2	Group 3
24"	\$ 3,420	\$ 3,560	\$ 4,500
30"	\$ 3,620	\$ 3,795	\$ 4,850
36"	\$ 3,820	\$ 4,035	\$ 5,210
42"	\$ 4,020	\$ 4,265	\$ 5,570
48"	\$ 4,220	\$ 4,500	\$ 5,915
54"	\$ 4,420	\$ 4,730	\$ 6,275
60"	\$ 4,620	\$ 4,970	\$ 6,635
66"	\$ 4,820	\$ 5,205	\$ 6,995
72"	\$ 5,010	\$ 5,440	\$ 7,345
78"	\$ 5,210	\$ 5,670	\$ 7,700
84"	\$ 5,410	\$ 5,905	\$ 8,060
Double Basin by Color Group			
Item	Group 1	Group 2	Group 3
48"	\$ 5,985	\$ 6,265	\$ 7,980
54"	\$ 6,185	\$ 6,495	\$ 8,340
60"	\$ 6,385	\$ 6,730	\$ 8,695
66"	\$ 6,575	\$ 6,970	\$ 9,055
72"	\$ 6,775	\$ 7,200	\$ 9,405
78"	\$ 6,975	\$ 7,435	\$ 9,765
84"	\$ 7,175	\$ 7,665	\$ 10,125
Triple Basin by Color Group			
Item	Group 1	Group 2	Group 3
72"	\$ 8,540	\$ 8,968	\$ 11,470
78"	\$ 8,740	\$ 9,195	\$ 11,830
84"	\$ 8,940	\$ 9,430	\$ 12,185

**Overflow**

Required. Order separately. See **Order Example** at lower left of page. For double and triple counters order two or three overflows.

See Metal Finish Codes below.

Item	Single Price			
Overflow	1	2	3	4
911.XX Round	\$ 255	\$ 255	\$ 260	\$ 285
916.XX Oval	\$ 255	\$ 255	\$ 260	\$ 285

**Drain** Optional. Order separately.

For double and triple counters order two or three drains. See Metal Finish Codes below.

Item	Single Price			
Grid Strainer Set	1	2	3	4
810.XX w US PTrap	\$ 330	\$ 575	\$ 750	\$ 820
810.XX.S w Siphon	\$ 455	\$ 670	\$ 855	\$ 920

**Dome Open Set**

860.XX w US PTrap	\$ 330	\$ 575	\$ 750	\$ 820
860.XX.S w Siphon	\$ 455	\$ 670	\$ 855	\$ 920

**Dome Pop-up Set**

862.XX w US PTrap	\$ 330	\$ 575	\$ 750	\$ 820
862.XX.S w Siphon	\$ 455	\$ 670	\$ 855	\$ 920

**Metal Finish Codes**

1	2	3	4
10 Pol. Chrome	12 Pol. Nickel 20 Sat. Chrome 22 Sat. Nickel	15 ORB 16 Pol. Brass*	13 Pol. Gold* 23 Sat. Gold*

\* Brass and Gold Finishes are PVD.

Order Example	A	B	C	D	E	Select an option in each column A-E including Overflow (required) and Drain (optional).
Countersink Item No.	450	B	F	F	66"	
Countersink Price	-	-	\$295	-	\$6,995	Basin Price \$ 7,290
	Single Oval Basin	Blue	Frosted	Overflow	Width	
Overflow Item No.	916	12	Oval Overflow / Pol. Nickel Metal Finish (12)			Overflow Price \$ + 255
Drain Item No.	860	12	Dome Open / Overflow / US PTrap / Pol. Nickel Metal Finish 12			Drain Price \$ + 575
						Total Price \$ 8,120

**Crating Charges:** 24-41" width: \$560, 42-60" width: \$740, 61-84" width: \$980. Up to 2 Countersinks per crate. Freight additional, request quotation.

For Mounting Hardware see pages 54-58



Countersink / Round or Oval Basin Without Overflow To order, select an option in each of columns A-E. Order Drain Collar and Drain separately. See Order Example at bottom.

Retail Price List

**A Specify Model**

Single Basin	
Item	Description
<b>Rectangular Front</b>	
300	Single Round Basin
350	Single Oval Basin
<b>Radius front</b>	
400	Single Round Basin
450	Single Oval Basin
<b>Double Basin</b>	
<b>Rectangular Front</b>	
302	Double Round Basin
352	Double Oval Basin
<b>Radius front</b>	
402	Double Round Basin
452	Double Oval Basin
<b>Triple Basin</b>	
<b>Rectangular Front</b>	
303	Triple Round Basin
353	Triple Oval Basin
<b>Radius front</b>	
403	Triple Round Basin
453	Triple Oval Basin

**B Glass Color**

All Vitraform glass has color at the edge. None are devoid of color.

Color Group 1	
Item	Color
C	Clear
S	Starphire®
Z	Bronze
G	Grey
K	Black
Color Group 2	
P	Peach
A	Azurlite®
X	Solex®
Color Group 3	
T	Cobalt
B	Blue

For White color specify Starphire glass in Color Group 1 with White Lami Finish in Column C.

**C Glass Finish**

1 Frosted finish on bottom surface only.  
2 Satin Etched finish on top and bottom surface.  
3 White Lami, Mirror, Chalk or Pearl not available on Black.  
4 White Lami or Chalk not available on Cobalt.

Item	Finish	Add
P	Polished	\$ 00
F	Frosted <sup>1</sup>	
	24"-36" width	\$ 195
	37"-60" width	\$ 235
	61"-84" width	\$ 295
O	White Lami <sup>3 4</sup>	
	24"-36" width	\$ 195
	37"-60" width	\$ 235
	61"-84" width	\$ 295
S	Satin Etched <sup>2</sup>	
	24"-36" width	\$ 385
	37"-60" width	\$ 470
	61"-84" width	\$ 595
M	Mirror <sup>3</sup>	
	24"-36" width	\$ 725
	37"-60" width	\$ 1,090
H	Chalk <sup>3 4</sup>	
	24"-36" width	\$ 580
	37"-60" width	\$ 710
	61"-84" width	\$ 890
E	Pearl <sup>3</sup>	
	24"-36" width	\$ 1,115
	37"-60" width	\$ 1,560
	61"-84" width	\$ 2,120

**D Drain Collar**

Drain Collar is required but is NOT included. Order separately. See Drain Collar column at right.

Item	Description
C	Drain Collar

**E Specify Width**

Priced in 6" increments. Drawings provided by Vitraform to exact dimension required.

Single Basin by Color Group			
Item	Group 1	Group 2	Group 3
24"	\$ 3,420	\$ 3,560	\$ 4,500
30"	\$ 3,620	\$ 3,795	\$ 4,850
36"	\$ 3,820	\$ 4,035	\$ 5,210
42"	\$ 4,020	\$ 4,265	\$ 5,570
48"	\$ 4,220	\$ 4,500	\$ 5,915
54"	\$ 4,420	\$ 4,730	\$ 6,275
60"	\$ 4,620	\$ 4,970	\$ 6,635
66"	\$ 4,820	\$ 5,205	\$ 6,995
72"	\$ 5,010	\$ 5,440	\$ 7,345
78"	\$ 5,210	\$ 5,670	\$ 7,700
84"	\$ 5,410	\$ 5,905	\$ 8,060

Double Basin by Color Group			
Item	Group 1	Group 2	Group 3
48"	\$ 5,985	\$ 6,265	\$ 7,980
54"	\$ 6,185	\$ 6,495	\$ 8,340
60"	\$ 6,385	\$ 6,730	\$ 8,695
66"	\$ 6,575	\$ 6,970	\$ 9,055
72"	\$ 6,775	\$ 7,200	\$ 9,405
78"	\$ 6,975	\$ 7,435	\$ 9,765
84"	\$ 7,175	\$ 7,665	\$ 10,125

Triple Basin by Color Group			
Item	Group 1	Group 2	Group 3
72"	\$ 8,540	\$ 8,968	\$ 11,470
78"	\$ 8,740	\$ 9,195	\$ 11,830
84"	\$ 8,940	\$ 9,430	\$ 12,185

**Drain Collar** Required. Order separately.

Required. Order separately. See **Order Example** at lower left of page. For double and triple counters order two or three overflows.

See Metal Finish Codes below.				
Item	Single Price			
<b>Drain Collar</b>	<b>1</b>	<b>2</b>	<b>3</b>	<b>4</b>
900.XX	\$ 50	\$ 50	\$ 55	\$ 60

**Drain** Optional. Order separately.

For double and triple counters order two or three drains. See Metal Finish Codes below.

Item	Single Price			
<b>Grid Strainer Set</b>	<b>1</b>	<b>2</b>	<b>3</b>	<b>4</b>
811.XX w US PTrap	\$ 330	\$ 575	\$ 750	\$ 820
811.XX.S w Siphon	\$ 455	\$ 670	\$ 855	\$ 920

<b>Dome Open Set</b>				
861.XX w US PTrap	\$ 330	\$ 575	\$ 750	\$ 820
861.XX.S w Siphon	\$ 455	\$ 670	\$ 855	\$ 920

<b>Dome Pop-up Set</b>				
863.XX w US PTrap	\$ 330	\$ 575	\$ 750	\$ 820
863.XX.S w Siphon	\$ 455	\$ 670	\$ 855	\$ 920

**Metal Finish Codes**

1	2	3	4
10 Pol. Chrome	12 Pol. Nickel 20 Sat. Chrome 22 Sat. Nickel	15 ORB 16 Pol. Brass*	13 Pol. Gold* 23 Sat. Gold*

\* Brass and Gold Finishes are PVD.

Order Example	A	B	C	D	E	Select an option in each column A-E including Drain Collar (required) and Drain (optional).	
Countersink Item No.	300	S	O	C	36"	Basin Price	\$ 4,015
Countersink Price	-	-	\$195	-	\$3,820		
Single Round Basin		White Lami	Drain Collar	Width			
		Starphire					
Drain Collar Item No.	900	16	Drain Collar / PVD Pol. Brass Metal Finish (16)			Drain Collar Price	\$ + 55
Drain Item No.	861	16S	Dome Drain Set / Siphon / PVD Pol. Brass Metal Finish (16)			Drain Price	\$ + 855
						Total Price	\$ 4,925

**Crating Charges:** 24-41" width: \$560, 42-60" width: \$740, 61-84" width: \$980. Up to 2 Countersinks per crate. Freight additional, request quotation.

For Mounting Hardware see pages 54-58



## Countersink / Rectangular Basin With Overflow

To order, select an option in each of columns A–E. Order overflow and Drain separately. Include Item No. and Price. See Example at bottom of page.

Retail Price List

A Specify Model		B Glass Color		C Glass Finish			D Overflow		E Specify Width					
Small Rectangular Basin 17 x 22 in. Rectangular Basin 18 x 24 in.		All Vitraform glass has color at the edge. None are devoid of color.		1 Frosted finish on bottom surface only. 2 Satin Etched finish on top and bottom surface. 3 White Lami, Mirror, Chalk or Pearl not available on Black. 4 White Lami or Chalk not available on Cobalt.			Overflow required but NOT included. Order separately. See Overflow column at right.		Priced in 6" increments. Drawings provided by Vitraform to exact dimension required.					
<b>Single Basin</b>		<b>Color Group 1</b>		<b>Item</b>	<b>Finish</b>	<b>Add</b>	<b>Item</b>	<b>Single Basin</b> by Color Group						
<b>Item</b>	<b>Description</b>	<b>Item</b>	<b>Color</b>					<b>Item</b>	<b>Group 1</b>	<b>Group 2</b>	<b>Group 3</b>			
<b>Rectangular Front</b>		C	Clear	P	Polished	\$ 00	F	Overflow	30"	\$ 3,620	\$ 3,795	\$ 4,850		
340	Small Single Rect. Basin	S	Starphire®	F	Frosted <sup>1</sup>				36"	\$ 3,820	\$ 4,035	\$ 5,210		
370	Single Rect. Basin	Z	Bronze		30"-36" width	\$ 195			42"	\$ 4,020	\$ 4,265	\$ 5,570		
<b>Radius Front</b>		G	Grey		37"-60" width	\$ 235			48"	\$ 4,220	\$ 4,500	\$ 5,915		
440	Small Single Rect. Basin	K	Black		61"-84" width	\$ 295			54"	\$ 4,420	\$ 4,730	\$ 6,275		
470	Single Rect. Basin			O	White Lami <sup>3 4</sup>				60"	\$ 4,620	\$ 4,970	\$ 6,635		
					30"-36" width	\$ 195			66"	\$ 4,820	\$ 5,205	\$ 6,995		
<b>Double Basin</b>		<b>Color Group 2</b>			37"-60" width	\$ 235			72"	\$ 5,010	\$ 5,440	\$ 7,345		
<b>Rectangular Front</b>		P	Peach		61"-84" width	\$ 295			78"	\$ 5,210	\$ 5,670	\$ 7,700		
342	Small Double Rect. Basin	A	Azurlite®	S	Satin Etched <sup>2</sup>				84"	\$ 5,410	\$ 5,905	\$ 8,060		
372	Double Rect. Basin	X	Solex®		30"-36" width	\$ 385			<b>Double Basin</b> by Color Group					
<b>Radius Front</b>		<b>Color Group 3</b>			37"-60" width	\$ 470			<b>Item</b>	<b>Group 1</b>	<b>Group 2</b>	<b>Group 3</b>		
442	Small Double Rect. Basin	T	Cobalt		61"-84" width	\$ 595			60"	\$ 6,385	\$ 6,730	\$ 8,695		
472	Double Rect. Basin	B	Blue	M	Mirror <sup>3</sup>				66"	\$ 6,575	\$ 6,970	\$ 9,055		
		For White color specify Starphire glass in Color Group 1 with White Lami Finish in Column C.			30"-36" width	\$ 725			72"	\$ 6,775	\$ 7,200	\$ 9,405		
				H	Chalk <sup>3 4</sup>				78"	\$ 6,975	\$ 7,435	\$ 9,765		
					30"-36" width	\$ 580			84"	\$ 7,175	\$ 7,665	\$ 10,125		
					37"-60" width	\$ 710								
					61"-84" width	\$ 890								
				E	Pearl <sup>3</sup>									
					30"-36" width	\$ 1,115								
					37"-60" width	\$ 1,560								
					61"-84" width	\$ 2,120								



Overflow Required. Order separately.				
Required. Order separately. See <b>Order Example</b> at lower left of page. For double counters order two overflows.				
See Metal Finish Codes below.				
<b>Item</b>	<b>Single Price</b>			
<b>Overflow</b>	<b>1</b>	<b>2</b>	<b>3</b>	<b>4</b>
918.XX Rectangular	\$ 255	\$ 255	\$ 260	\$ 285
Drain Optional. Order separately.				
For double counters order two drains.				
See Metal Finish Codes below.				
<b>Item</b>	<b>Single Price</b>			
<b>Grid Strainer Set</b>	<b>1</b>	<b>2</b>	<b>3</b>	<b>4</b>
810.XX w US PTrap	\$ 330	\$ 575	\$ 750	\$ 820
810.XX.S w Siphon	\$ 455	\$ 670	\$ 855	\$ 920
Dome Open Set				
860.XX w US PTrap	\$ 330	\$ 575	\$ 750	\$ 820
860.XX.S w Siphon	\$ 455	\$ 670	\$ 855	\$ 920
Dome Pop-up Set				
862.XX w US PTrap	\$ 330	\$ 575	\$ 750	\$ 820
862.XX.S w Siphon	\$ 455	\$ 670	\$ 855	\$ 920
Metal Finish Codes				
<b>1</b>	<b>2</b>	<b>3</b>	<b>4</b>	
10 Pol. Chrome	12 Pol. Nickel	15 ORB	13 Pol. Gold*	
	20 Sat. Chrome	16 Pol. Brass*	23 Sat. Gold*	
	22 Sat. Nickel			
* Brass and Gold Finishes are PVD.				

Order Example	A	B	C	D	E	Select an option in each column A-E including Overflow (required) and Drain (optional).	
Countersink Item No.	370	P	F	F	72"	Basin Price	\$ 5,735
Countersink Price	-	-	\$ 295	-	\$ 5,440		
	Single Rect. Basin	Peach	Frosted	Overflow	Width		
Overflow Item No.	918	10	Rectangular Overflow / Pol. Chrome Metal Finish (10)			Overflow Price	\$ + 255
Drain Item No.	860	10	Dome Open / Overflow / US PTrap / Pol. Chrome Metal Finish 10			Drain Price	\$ + 330
						<b>Total Price</b>	<b>\$ 6,320</b>

Crating Charges: 30-41" width: \$560,  
42-60" width: \$740, 61-84" width: \$980.  
Up to 2 Countersinks per crate. Freight additional, request quotation.

For Mounting Hardware see pages 54-58

Countersink Rectangular Basin Without Overflow To order, select an option in each of columns A–E. Order Drain Collar and Drain separately. See Example at bottom of page.

Retail Price List

A Specify Model		B Glass Color		C Glass Finish			D Drain Collar		E Specify Width				
Small Rectangular Basin 17 x 22 in. Rectangular Basin 18 x 24 in.		All Vitraform glass has color at the edge. None are devoid of color.		1 Frosted finish on bottom surface only. 2 Satin Etched finish on top and bottom surface. 3 White Lami, Mirror, Chalk or Pearl not available on Black. 4 White Lami or Chalk not available on Cobalt.			Drain Collar is required but is NOT included. Order separately. See Drain Collar column at right.		Priced in 6" increments. Drawings provided by Vitraform to exact dimension required.				
<b>Single Basin</b>		<b>Color Group 1</b>		<b>Item</b> <b>Finish</b> <b>Add</b>			<b>Item</b>		<b>Single Basin</b> by Color Group				
<b>Item</b>	<b>Description</b>	<b>Item</b>	<b>Color</b>	<b>Item</b>	<b>Finish</b>	<b>Add</b>	<b>Item</b>	<b>Group 1</b>	<b>Group 2</b>	<b>Group 3</b>	<b>Group 1</b>	<b>Group 2</b>	<b>Group 3</b>
<b>Rectangular Front</b>		C	Clear	P	Polished	\$ 00	C	Drain Collar	30"	\$ 3,620	\$ 3,795	\$ 4,850	
340	Small Single Rect. Basin	S	Starphire®	F	Frosted <sup>1</sup>				36"	\$ 3,820	\$ 4,035	\$ 5,210	
370	Single Rect. Basin	Z	Bronze		30"-36" width	\$ 195			42"	\$ 4,020	\$ 4,265	\$ 5,570	
<b>Radius Front</b>		G	Grey		37"-60" width	\$ 235			48"	\$ 4,220	\$ 4,500	\$ 5,915	
440	Small Single Rect. Basin	K	Black		61"-84" width	\$ 295			54"	\$ 4,420	\$ 4,730	\$ 6,275	
470	Single Rect. Basin			O	White Lami <sup>3 4</sup>				60"	\$ 4,620	\$ 4,970	\$ 6,635	
					30"-36" width	\$ 195			66"	\$ 4,820	\$ 5,205	\$ 6,995	
<b>Double Basin</b>		<b>Color Group 2</b>		<b>Item</b> <b>Finish</b> <b>Add</b>			<b>Item</b>		<b>Double Basin</b> by Color Group				
<b>Item</b>	<b>Description</b>	<b>Item</b>	<b>Color</b>	<b>Item</b>	<b>Finish</b>	<b>Add</b>	<b>Item</b>	<b>Group 1</b>	<b>Group 2</b>	<b>Group 3</b>	<b>Group 1</b>	<b>Group 2</b>	<b>Group 3</b>
<b>Rectangular Front</b>		P	Peach	S	Satin Etched <sup>2</sup>				60"	\$ 6,385	\$ 6,730	\$ 8,695	
342	Small Double Rect. Basin	A	Azurlite®		30"-36" width	\$ 385			66"	\$ 6,575	\$ 6,970	\$ 9,055	
372	Double Rect. Basin	X	Solex®		37"-60" width	\$ 470			72"	\$ 6,775	\$ 7,200	\$ 9,405	
<b>Radius Front</b>		<b>Color Group 3</b>		<b>Item</b> <b>Finish</b> <b>Add</b>			<b>Item</b>		<b>Double Basin</b> by Color Group				
442	Small Double Rect. Basin	T	Cobalt	M	Mirror <sup>3</sup>				60"	\$ 6,385	\$ 6,730	\$ 8,695	
472	Double Rect. Basin	B	Blue		30"-36" width	\$ 725			66"	\$ 6,575	\$ 6,970	\$ 9,055	
					37"-60" width	\$ 1,090			72"	\$ 6,775	\$ 7,200	\$ 9,405	
					61"-84" width	\$ 1,905			78"	\$ 6,975	\$ 7,435	\$ 9,765	
					30"-36" width	\$ 580			84"	\$ 7,175	\$ 7,665	\$ 10,125	
					37"-60" width	\$ 710							
					61"-84" width	\$ 890							
				E	Pearl <sup>3</sup>								
					30"-36" width	\$ 1,115							
					37"-60" width	\$ 1,560							
					61"-84" width	\$ 2,120							

Drain Collar Required. Order separately.				
Required. Order separately. See <b>Order Example</b> at lower left of page. For double counters order two overflows.				
See Metal Finish Codes below.				
Item	Single Price			
Drain Collar	1	2	3	4
900.XX	\$ 50	\$ 50	\$ 55	\$ 60
Drain Optional. Order separately.				
For double counters order two drains.				
See Metal Finish Codes below.				
Item	Single Price			
Grid Strainer Set	1	2	3	4
811.XX w US PTrap	\$ 330	\$ 575	\$ 750	\$ 820
811.XX.S w Siphon	\$ 455	\$ 670	\$ 855	\$ 920
Dome Open Set				
861.XX w US PTrap	\$ 330	\$ 575	\$ 750	\$ 820
861.XX.S w Siphon	\$ 455	\$ 670	\$ 855	\$ 920
Dome Pop-up Set				
863.XX w US PTrap	\$ 330	\$ 575	\$ 750	\$ 820
863.XX.S w Siphon	\$ 455	\$ 670	\$ 855	\$ 920
Metal Finish Codes				
1	2	3	4	
10 Pol. Chrome	12 Pol. Nickel 20 Sat. Chrome 22 Sat. Nickel	15 ORB 16 Pol. Brass*	13 Pol. Gold* 23 Sat. Gold*	
* Brass and Gold Finishes are PVD.				



Order Example	A	B	C	D	E	Select an option in each column A-E including Drain Collar (required) and Drain (optional).	
Countersink Item No.	370	C	P	C	42"	Basin Price	\$ 4,020
Countersink Price	-	-	\$ 00	-	\$ 4,020		
	Single Rect. Basin	Polished	Width				
	Clear	Drain Collar					
Drain Collar Item No.	900	12	Drain Collar / Pol. Nickel Metal Finish (12)		Drain Collar Price	\$ + 50	
Drain Item No.	861	12S	Dome Drain Set / Siphon / Pol. Nickel Metal Finish (12)		Drain Price	\$ + 670	
					Total Price	\$ 4,740	

Crating Charges: 30-41" width: \$560, 42-60" width: \$740, 61-84" width: \$980.  
Up to 2 Countersinks per crate. Freight additional, request quotation.

For Mounting Hardware see pages 54-58

Console and Washstand



Radius Front Console with Oval Basin in Starphire White Lami with Chrome Legs and Towel Bar.



Washstand with Oval Basin in Black Polished with Chrome Hardware.



Countersink Console / Round or Oval Basin With Overflow To order, select an option in each of columns A-F. Include Item No. and Price. See Example at bottom of page.

Retail Price List

A Specify Model		B Glass Color		C Glass Finish			D Overflow		E Specify Width				F Select Metal Finish			
Prices are for complete Console *		All Vitraform glass has color at the edge. None are devoid of color.		1 Frosted finish on bottom surface only. 2 Satin Etched finish on top and bottom surface. 3 White Lami, Mirror, Chalk or Pearl not available on Black. 4 White Lami or Chalk not available on Cobalt.			Overflow included.		Single Basin Pricing				Single      Double			
<b>Single Basin</b>		<b>Color Group 1</b>		<b>Item</b>	<b>Finish</b>	<b>Add</b>	<b>Item</b>	<b>Item</b>	Group 1	Group 2	Group 3	<b>Item</b>	<b>Description</b>	<b>Add</b>	<b>Add</b>	
<b>Rectangular Front</b>		C	Clear	P	Polished	\$ 00	F	F				10	Pol. Chrome	\$ 00	\$ 00	
330	Single Round Basin	S	Starphire®	F	Frosted <sup>1</sup>			24"	\$ 8,060	\$ 8,340	\$ 8,905	12	Pol. Nickel	\$ 220	\$ 440	
380	Single Oval Basin	Z	Bronze		20"-36" width	\$ 385		30"	\$ 8,460	\$ 8,805	\$ 9,510	20	Sat. Chrome	\$ 220	\$ 440	
390	Single Rect. Basin	G	Grey		37"-60" width	\$ 465		36"	\$ 8,850	\$ 9,280	\$ 10,115	22	Sat. Nickel	\$ 220	\$ 440	
<b>Radius front</b>		K	Black	O	White Lami <sup>3 4</sup>			42"	\$ 9,250	\$ 9,745	\$ 10,730	15	ORB	\$ 585	\$ 985	
430	Single Round Basin	<b>Color Group 2</b>			20"-36" width	\$ 385		48"	\$ 9,650	\$ 10,210	\$ 11,335	16	PVD Pol. Brass	\$ 585	\$ 985	
480	Single Oval Basin	P	Peach	S	Satin Etched <sup>2</sup>			54"	\$ 10,500	\$ 10,685	\$ 11,945	13	PVD Pol. Gold	\$ 1,000	\$ 1,460	
490	Single Rect. Basin	A	Azurlite®		37"-60" width	\$ 465		60"	\$ 10,450	\$ 11,155	\$ 12,550	23	PVD Sat. Gold	\$ 1,000	\$ 1,460	
<b>Double Basin</b>		X	Solex®	M	Mirror <sup>3</sup>			<b>Double Basin Pricing</b>								
<b>Rectangular Front</b>		<b>Color Group 3</b>			20"-36" width	\$ 1,450		<b>Item</b>	Group 1	Group 2	Group 3					
332	Double Round Basin	T	Cobalt		37"-60" width	\$ 2,180		48"	\$ 12,330	\$ 12,890	\$ 14,010					
382	Double Oval Basin	B	Blue	H	Chalk <sup>3 4</sup>			54"	\$ 12,725	\$ 13,355	\$ 14,620					
392	Double Rect. Basin	For White color specify Starphire glass in Color Group 1 with White Lami Finish in Column C.			20"-36" width	\$ 1,160		60"	\$ 13,125	\$ 13,820	\$ 15,230					
<b>Radius front</b>				E	Pearl <sup>3</sup>											
432	Double Round Basin				20"-36" width	\$ 2,225										
482	Double Oval Basin				37"-60" width	\$ 3,110										
492	Double Rect. Basin															
* Includes CounterSink, Drain Set, Shelf, Mounting Clips, Console Legs, Towel Bar and Overflow.																
Dome Pop-up drain and Euro Siphon included as standard. Contact factory to substitute a US P-trap or any other Vitraform drain with the Console.																
Shape of counter is dependent on shape of basin.																



Order Example	A	B	C	D	E	F	To order, select an option in each of columns A - F and add Crating Charges.	
Console Item No.	380	X	P	F	54"	22	Total Price	\$ 10,905
Console Price	-	-	\$ 00	-	\$10,685	\$ 220		
	Single Oval Basin	Solex Glass	Polished Finish	Overflow	Width of Counter	Sat. Nickel Metal Finish		
Crating Charges per Console: 24-41" width: \$560, 42-60" width: \$740. Freight additional, request quotation.								

Countersink Console / Round or Oval Basin Without Overflow Retail Price List

A Specify Model		B Glass Color		C Glass Finish			D Drain Collar		E Specify Width				F Select Metal Finish			
Prices are for complete Console *		All Vitraform glass has color at the edge. None are devoid of color.		1 Frosted finish on bottom surface only. 2 Satin Etched finish on top and bottom surface. 3 White Lami, Mirror, Chalk or Pearl not available on Black. 4 White Lami or Chalk not available on Cobalt.			Drain Collar included									
Single Basin		Color Group 1							Single Basin Pricing							
Item	Description	Item	Color	Item	Finish	Add	Item		Item	Group 1	Group 2	Group 3	Item	Description	Single Add	Double Add
<b>Rectangular Front</b>		C	Clear	P	Polished	\$ 00	C	Drain Collar	24"	\$ 7,855	\$ 8,135	\$ 8,700	10	Pol. Chrome	\$ 00	\$ 00
330	Single Round Basin	S	Starphire®	F	Frosted <sup>1</sup>				30"	\$ 8,255	\$ 8,600	\$ 9,305	12	Pol. Nickel	\$ 220	\$ 440
380	Single Oval Basin	Z	Bronze		20"-36" width	\$ 385			36"	\$ 8,645	\$ 9,075	\$ 9,910	20	Sat. Chrome	\$ 220	\$ 440
390	Single Rect. Basin	G	Grey		37"-60" width	\$ 465			42"	\$ 9,045	\$ 9,540	\$ 10,525	22	Sat. Nickel	\$ 220	\$ 440
<b>Radius front</b>		K	Black	O	White Lami <sup>3 4</sup>				48"	\$ 9,445	\$ 10,005	\$ 11,130	15	ORB	\$ 585	\$ 985
430	Single Round Basin				20"-36" width	\$ 385			54"	\$ 9,845	\$ 10,480	\$ 11,740	16	PVD Pol. Brass	\$ 585	\$ 985
480	Single Oval Basin	<b>Color Group 2</b>		S	Satin Etched <sup>2</sup>				60"	\$ 10,245	\$ 10,950	\$ 12,345	13	PVD Pol. Gold	\$ 1,000	\$ 1,460
490	Single Rect. Basin	P	Peach		37"-60" width	\$ 465			<b>Double Basin Pricing</b>				23	PVD Sat. Gold	\$ 1,000	\$ 1,460
<b>Double Basin</b>		A	Azurlite®	M	Mirror <sup>3</sup>				Item	Group 1	Group 2	Group 3				
<b>Rectangular Front</b>		X	Solex®		20"-36" width	\$ 775			48"	\$ 11,920	\$ 12,480	\$ 13,600				
332	Double Round Basin	<b>Color Group 3</b>			37"-60" width	\$ 930			54"	\$ 12,315	\$ 12,945	\$ 14,210				
382	Double Oval Basin	T	Cobalt		20"-36" width	\$ 1,450			60"	\$ 12,615	\$ 13,410	\$ 14,820				
392	Double Rect. Basin	B	Blue	H	Chalk <sup>3 4</sup>											
<b>Radius front</b>		For White color specify Starphire glass in Color Group 1 with White Lami Finish in Column C.			20"-36" width	\$ 1,160										
432	Double Round Basin				37"-60" width	\$ 1,400										
482	Double Oval Basin			E	Pearl <sup>3</sup>											
492	Double Rect. Basin				20"-36" width	\$ 2,225										
					37"-60" width	\$ 3,110										



Order Example	A	B	C	D	E	F	To order, select an option in each of columns A – F and add Crating Charges.	
Console Item No.	482	X	P	C	54"	22	Total Price	\$ 13,385
Console Price	-	-	\$ 00	-	\$12,945	\$ 440		
Double Oval Basin		Polished Finish		Width of Counter				
Solex Glass		Drain Collar		Sat. Nickel Metal Finish				
Crating Charges per Console: 24-41" width: \$560, 42-60" width: \$740. Freight additional, request quotation.								

Countersink Washstand / Round or Oval Basin With Overflow

To order, select an option in each of columns A-F. Include Item No. and Price. See Example at bottom of page.

Retail Price List

A Specify Model		B Glass Color		C Glass Finish			D Overflow		E Specify Width				F Select Metal Finish			
Prices are for complete Washstand*		All Vitraform glass has color at the edge. None are devoid of color.					Overflow included.									
<b>Single Basin</b>		<b>Color Group 1</b>							<b>Single Basin Washstand Pricing</b>							
<b>Item</b>	<b>Description</b>	<b>Item</b>	<b>Color</b>	<b>Item</b>	<b>Finish</b>	<b>Add</b>	<b>Item</b>		<b>Item</b>	<b>Group 1</b>	<b>Group 2</b>	<b>Group 3</b>	<b>Item</b>	<b>Description</b>	<b>Single Add</b>	<b>Double Add</b>
<b>Rectangular Front</b>		C	Clear	P	Polished <sup>5</sup>	\$ 00	F	Overflow	24"	\$ 9,425	\$ 10,130	\$ 11,535	10	Pol. Chrome	\$ 00	\$ 00
310	Single Round Basin	S	Starphire®	O	White Lami <sup>3,4</sup>				30"	\$ 9,825	\$ 10,595	\$ 12,140	12	Pol. Nickel	\$ 220	\$ 440
360	Single Oval Basin	Z	Bronze		20"-36" width	\$ 775			36"	\$ 10,215	\$ 11,070	\$ 12,745	20	Sat. Chrome	\$ 220	\$ 440
320	Single Rect. Basin	G	Grey		37"-60" width	\$ 855			42"	\$ 10,615	\$ 11,535	\$ 13,360	22	Sat. Nickel	\$ 220	\$ 440
<b>Double Basin</b>		K	Black	S	Satin Etched <sup>2</sup>				48"	\$ 11,015	\$ 12,000	\$ 13,965	15	ORB	\$ 460	\$ 865
<b>Rectangular Front</b>		<b>Color Group 2</b>			20"-36" width	\$ 1,550			54"	\$ 11,415	\$ 12,470	\$ 14,575	16	PVD Pol. Brass	\$ 460	\$ 865
312	Double Round Basin	P	Peach	M	Mirror <sup>3</sup>				60"	\$ 11,815	\$ 12,945	\$ 15,180	13	PVD Pol. Gold	\$ 625	\$ 1,085
362	Double Oval Basin	A	Azurlite®		20"-36" width	\$ 2,905			<b>Double Basin Washstand Pricing</b>				23	PVD Sat. Gold	\$ 625	\$ 1,085
322	Double Rect. Basin	X	Solex®		37"-60" width	\$ 3,630			<b>Item</b>	<b>Group 1</b>	<b>Group 2</b>	<b>Group 3</b>				
* Includes Countersink, Drain Set, Shelf, Side Panels, Mounting Clips and Overflow.		<b>Color Group 3</b>		H	Chalk <sup>3,4</sup>				48"	\$ 13,285	\$ 14,270	\$ 16,235				
Dome Pop-up drain and Euro Siphon included as standard. Contact factory to substitute a US P-trap or any other Vitraform drain with the Washstand.		T	Cobalt		20"-36" width	\$ 2,325			54"	\$ 13,685	\$ 14,745	\$ 16,845				
Shape of counter is dependent on shape of basin.		B	Blue	E	Pearl <sup>3</sup>				60"	\$ 14,085	\$ 15,210	\$ 17,450				
		For White color specify Starphire glass in Color Group 1 with White Lami Finish in Column C.			20"-36" width	\$ 4,455										
					37"-60" width	\$ 5,340										
				2 Satin Etched finish on top and bottom surfaces of glass.												
				3 White Lami, Mirror, Chalk or Pearl not available on Black.												
				4 White Lami or Chalk not available on Cobalt.												
				5 Polished finish on glass colors other than Black or Cobalt is not recommended. Assembly by experienced glass installer using optically clear adhesive is necessary.												

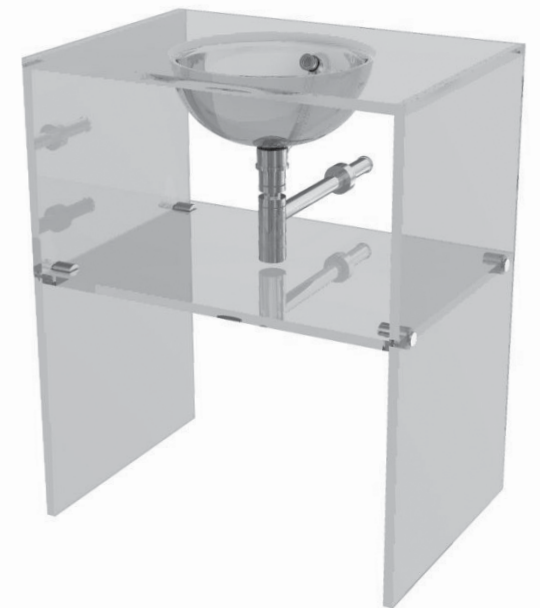

Order Example	A	B	C	D	E	F	To order, select an option in each of columns A - F and add Crating Charges.	
Washstand Item No.	360	S	S	F	54"	22		
Washstand Price	-	-	\$ 1,710	-	\$ 11,415	\$ 220	Total Price	\$ 13,345
	Single Oval Basin	Satin Etched Finish	Width of Counter					
	Starphire Glass	Overflow	Sat. Nickel Metal Finish					
Crating Charges per Washstand: 24-41" width: \$560, 42-60" width: \$740. Freight additional, request quotation.								

Countersink Washstand / Round or Oval Basin Without Overflow Retail Price List

A Specify Model	B Glass Color	C Glass Finish	D Drain Collar	E Specify Width	F Select Metal Finish																																																																																																																																																																																																									
<p>Prices are for complete Washstand*</p> <table border="1" style="width: 100%; border-collapse: collapse;"> <tr> <th colspan="2">Single Basin</th> </tr> <tr> <th>Item</th> <th>Description</th> </tr> <tr> <th colspan="2">Rectangular Front</th> </tr> <tr> <td>310</td> <td>Single Round Basin</td> </tr> <tr> <td>360</td> <td>Single Oval Basin</td> </tr> <tr> <td>320</td> <td>Single Rect. Basin</td> </tr> <tr> <th colspan="2">Double Basin</th> </tr> <tr> <th colspan="2">Rectangular Front</th> </tr> <tr> <td>312</td> <td>Double Round Basin</td> </tr> <tr> <td>362</td> <td>Double Oval Basin</td> </tr> <tr> <td>322</td> <td>Double Rect. Basin</td> </tr> </table> <p>* Includes Countersink, Drain Set, Shelf, Side Panels, Mounting Clips and Drain Collar.</p> <p>Dome Pop-up drain and Euro Siphon included as standard. Contact factory to substitute a US P-trap or any other Vitraform drain with the Washstand.</p> <p>Shape of counter is dependent on shape of basin.</p>	Single Basin		Item	Description	Rectangular Front		310	Single Round Basin	360	Single Oval Basin	320	Single Rect. Basin	Double Basin		Rectangular Front		312	Double Round Basin	362	Double Oval Basin	322	Double Rect. Basin	<p>All Vitraform glass has color at the edge. None are devoid of color.</p> <table border="1" style="width: 100%; border-collapse: collapse;"> <tr> <th colspan="2">Color Group 1</th> </tr> <tr> <th>Item</th> <th>Color</th> </tr> <tr> <td>C</td> <td>Clear</td> </tr> <tr> <td>S</td> <td>Starphire®</td> </tr> <tr> <td>Z</td> <td>Bronze</td> </tr> <tr> <td>G</td> <td>Grey</td> </tr> <tr> <td>K</td> <td>Black</td> </tr> <tr> <th colspan="2">Color Group 2</th> </tr> <tr> <td>P</td> <td>Peach</td> </tr> <tr> <td>A</td> <td>Azurlite®</td> </tr> <tr> <td>X</td> <td>Solex®</td> </tr> <tr> <th colspan="2">Color Group 3</th> </tr> <tr> <td>T</td> <td>Cobalt</td> </tr> <tr> <td>B</td> <td>Blue</td> </tr> </table> <p>For White color specify Starphire glass in Color Group 1 with White Lami Finish in Column C.</p>	Color Group 1		Item	Color	C	Clear	S	Starphire®	Z	Bronze	G	Grey	K	Black	Color Group 2		P	Peach	A	Azurlite®	X	Solex®	Color Group 3		T	Cobalt	B	Blue	<table border="1" style="width: 100%; border-collapse: collapse;"> <tr> <th>Item</th> <th>Finish</th> <th>Add</th> </tr> <tr> <td>P</td> <td>Polished <sup>5</sup></td> <td>\$ 00</td> </tr> <tr> <td>O</td> <td>White Lami <sup>3 4</sup></td> <td></td> </tr> <tr> <td></td> <td>20"-36" width</td> <td>\$ 775</td> </tr> <tr> <td></td> <td>37"-60" width</td> <td>\$ 855</td> </tr> <tr> <td>S</td> <td>Satin Etched <sup>2</sup></td> <td></td> </tr> <tr> <td></td> <td>20"-36" width</td> <td>\$ 1,550</td> </tr> <tr> <td></td> <td>37"-60" width</td> <td>\$ 1,710</td> </tr> <tr> <td>M</td> <td>Mirror <sup>3</sup></td> <td></td> </tr> <tr> <td></td> <td>20"-36" width</td> <td>\$ 2,905</td> </tr> <tr> <td></td> <td>37"-60" width</td> <td>\$ 3,630</td> </tr> <tr> <td>H</td> <td>Chalk <sup>3 4</sup></td> <td></td> </tr> <tr> <td></td> <td>20"-36" width</td> <td>\$ 2,325</td> </tr> <tr> <td></td> <td>37"-60" width</td> <td>\$ 2,565</td> </tr> <tr> <td>E</td> <td>Pearl <sup>3</sup></td> <td></td> </tr> <tr> <td></td> <td>20"-36" width</td> <td>\$ 4,455</td> </tr> <tr> <td></td> <td>37"-60" width</td> <td>\$ 5,340</td> </tr> </table> <p>2 Satin Etched finish on top and bottom surfaces of glass.                      3 White Lami, Mirror, Chalk or Pearl not available on Black.                      4 White Lami or Chalk not available on Cobalt.                      5 Polished finish on glass colors other than Black or Cobalt is not recommended. Assembly by experienced glass installer using optically clear adhesive is necessary.</p>	Item	Finish	Add	P	Polished <sup>5</sup>	\$ 00	O	White Lami <sup>3 4</sup>			20"-36" width	\$ 775		37"-60" width	\$ 855	S	Satin Etched <sup>2</sup>			20"-36" width	\$ 1,550		37"-60" width	\$ 1,710	M	Mirror <sup>3</sup>			20"-36" width	\$ 2,905		37"-60" width	\$ 3,630	H	Chalk <sup>3 4</sup>			20"-36" width	\$ 2,325		37"-60" width	\$ 2,565	E	Pearl <sup>3</sup>			20"-36" width	\$ 4,455		37"-60" width	\$ 5,340	<p>Drain Collar included.</p> <table border="1" style="width: 100%; border-collapse: collapse;"> <tr> <th>Item</th> <th>Description</th> </tr> <tr> <td>C</td> <td>Drain Collar</td> </tr> </table>	Item	Description	C	Drain Collar	<table border="1" style="width: 100%; border-collapse: collapse;"> <tr> <th colspan="4">Single Basin Washstand Pricing</th> </tr> <tr> <th>Item</th> <th>Group 1</th> <th>Group 2</th> <th>Group 3</th> </tr> <tr> <td>24"</td> <td>\$ 9,220</td> <td>\$ 9,925</td> <td>\$ 11,330</td> </tr> <tr> <td>30"</td> <td>\$ 9,620</td> <td>\$ 10,390</td> <td>\$ 11,935</td> </tr> <tr> <td>36"</td> <td>\$ 10,010</td> <td>\$ 10,865</td> <td>\$ 12,540</td> </tr> <tr> <td>42"</td> <td>\$ 10,410</td> <td>\$ 11,330</td> <td>\$ 13,155</td> </tr> <tr> <td>48"</td> <td>\$ 10,810</td> <td>\$ 11,795</td> <td>\$ 13,760</td> </tr> <tr> <td>54"</td> <td>\$ 11,210</td> <td>\$ 12,265</td> <td>\$ 14,370</td> </tr> <tr> <td>60"</td> <td>\$ 11,610</td> <td>\$ 13,010</td> <td>\$ 14,975</td> </tr> <tr> <th colspan="4">Double Basin Washstand Pricing</th> </tr> <tr> <th>Item</th> <th>Group 1</th> <th>Group 2</th> <th>Group 3</th> </tr> <tr> <td>48"</td> <td>\$ 12,875</td> <td>\$ 13,860</td> <td>\$ 15,825</td> </tr> <tr> <td>54"</td> <td>\$ 13,275</td> <td>\$ 14,335</td> <td>\$ 16,435</td> </tr> <tr> <td>60"</td> <td>\$ 13,675</td> <td>\$ 14,800</td> <td>\$ 17,040</td> </tr> </table>	Single Basin Washstand Pricing				Item	Group 1	Group 2	Group 3	24"	\$ 9,220	\$ 9,925	\$ 11,330	30"	\$ 9,620	\$ 10,390	\$ 11,935	36"	\$ 10,010	\$ 10,865	\$ 12,540	42"	\$ 10,410	\$ 11,330	\$ 13,155	48"	\$ 10,810	\$ 11,795	\$ 13,760	54"	\$ 11,210	\$ 12,265	\$ 14,370	60"	\$ 11,610	\$ 13,010	\$ 14,975	Double Basin Washstand Pricing				Item	Group 1	Group 2	Group 3	48"	\$ 12,875	\$ 13,860	\$ 15,825	54"	\$ 13,275	\$ 14,335	\$ 16,435	60"	\$ 13,675	\$ 14,800	\$ 17,040	<table border="1" style="width: 100%; border-collapse: collapse;"> <tr> <th colspan="2"></th> <th>Single</th> <th>Double</th> </tr> <tr> <th>Item</th> <th>Description</th> <th>Add</th> <th>Add</th> </tr> <tr> <td>10</td> <td>Pol. Chrome</td> <td>\$ 00</td> <td>\$ 00</td> </tr> <tr> <td>12</td> <td>Pol. Nickel</td> <td>\$ 220</td> <td>\$ 440</td> </tr> <tr> <td>20</td> <td>Sat. Chrome</td> <td>\$ 220</td> <td>\$ 440</td> </tr> <tr> <td>22</td> <td>Sat. Nickel</td> <td>\$ 220</td> <td>\$ 440</td> </tr> <tr> <td>15</td> <td>ORB</td> <td>\$ 460</td> <td>\$ 865</td> </tr> <tr> <td>16</td> <td>PVD Pol. Brass</td> <td>\$ 460</td> <td>\$ 865</td> </tr> <tr> <td>13</td> <td>PVD Pol. Gold</td> <td>\$ 625</td> <td>\$ 1,085</td> </tr> <tr> <td>23</td> <td>PVD Sat. Gold</td> <td>\$ 625</td> <td>\$ 1,085</td> </tr> </table>			Single	Double	Item	Description	Add	Add	10	Pol. Chrome	\$ 00	\$ 00	12	Pol. Nickel	\$ 220	\$ 440	20	Sat. Chrome	\$ 220	\$ 440	22	Sat. Nickel	\$ 220	\$ 440	15	ORB	\$ 460	\$ 865	16	PVD Pol. Brass	\$ 460	\$ 865	13	PVD Pol. Gold	\$ 625	\$ 1,085	23	PVD Sat. Gold	\$ 625	\$ 1,085
Single Basin																																																																																																																																																																																																														
Item	Description																																																																																																																																																																																																													
Rectangular Front																																																																																																																																																																																																														
310	Single Round Basin																																																																																																																																																																																																													
360	Single Oval Basin																																																																																																																																																																																																													
320	Single Rect. Basin																																																																																																																																																																																																													
Double Basin																																																																																																																																																																																																														
Rectangular Front																																																																																																																																																																																																														
312	Double Round Basin																																																																																																																																																																																																													
362	Double Oval Basin																																																																																																																																																																																																													
322	Double Rect. Basin																																																																																																																																																																																																													
Color Group 1																																																																																																																																																																																																														
Item	Color																																																																																																																																																																																																													
C	Clear																																																																																																																																																																																																													
S	Starphire®																																																																																																																																																																																																													
Z	Bronze																																																																																																																																																																																																													
G	Grey																																																																																																																																																																																																													
K	Black																																																																																																																																																																																																													
Color Group 2																																																																																																																																																																																																														
P	Peach																																																																																																																																																																																																													
A	Azurlite®																																																																																																																																																																																																													
X	Solex®																																																																																																																																																																																																													
Color Group 3																																																																																																																																																																																																														
T	Cobalt																																																																																																																																																																																																													
B	Blue																																																																																																																																																																																																													
Item	Finish	Add																																																																																																																																																																																																												
P	Polished <sup>5</sup>	\$ 00																																																																																																																																																																																																												
O	White Lami <sup>3 4</sup>																																																																																																																																																																																																													
	20"-36" width	\$ 775																																																																																																																																																																																																												
	37"-60" width	\$ 855																																																																																																																																																																																																												
S	Satin Etched <sup>2</sup>																																																																																																																																																																																																													
	20"-36" width	\$ 1,550																																																																																																																																																																																																												
	37"-60" width	\$ 1,710																																																																																																																																																																																																												
M	Mirror <sup>3</sup>																																																																																																																																																																																																													
	20"-36" width	\$ 2,905																																																																																																																																																																																																												
	37"-60" width	\$ 3,630																																																																																																																																																																																																												
H	Chalk <sup>3 4</sup>																																																																																																																																																																																																													
	20"-36" width	\$ 2,325																																																																																																																																																																																																												
	37"-60" width	\$ 2,565																																																																																																																																																																																																												
E	Pearl <sup>3</sup>																																																																																																																																																																																																													
	20"-36" width	\$ 4,455																																																																																																																																																																																																												
	37"-60" width	\$ 5,340																																																																																																																																																																																																												
Item	Description																																																																																																																																																																																																													
C	Drain Collar																																																																																																																																																																																																													
Single Basin Washstand Pricing																																																																																																																																																																																																														
Item	Group 1	Group 2	Group 3																																																																																																																																																																																																											
24"	\$ 9,220	\$ 9,925	\$ 11,330																																																																																																																																																																																																											
30"	\$ 9,620	\$ 10,390	\$ 11,935																																																																																																																																																																																																											
36"	\$ 10,010	\$ 10,865	\$ 12,540																																																																																																																																																																																																											
42"	\$ 10,410	\$ 11,330	\$ 13,155																																																																																																																																																																																																											
48"	\$ 10,810	\$ 11,795	\$ 13,760																																																																																																																																																																																																											
54"	\$ 11,210	\$ 12,265	\$ 14,370																																																																																																																																																																																																											
60"	\$ 11,610	\$ 13,010	\$ 14,975																																																																																																																																																																																																											
Double Basin Washstand Pricing																																																																																																																																																																																																														
Item	Group 1	Group 2	Group 3																																																																																																																																																																																																											
48"	\$ 12,875	\$ 13,860	\$ 15,825																																																																																																																																																																																																											
54"	\$ 13,275	\$ 14,335	\$ 16,435																																																																																																																																																																																																											
60"	\$ 13,675	\$ 14,800	\$ 17,040																																																																																																																																																																																																											
		Single	Double																																																																																																																																																																																																											
Item	Description	Add	Add																																																																																																																																																																																																											
10	Pol. Chrome	\$ 00	\$ 00																																																																																																																																																																																																											
12	Pol. Nickel	\$ 220	\$ 440																																																																																																																																																																																																											
20	Sat. Chrome	\$ 220	\$ 440																																																																																																																																																																																																											
22	Sat. Nickel	\$ 220	\$ 440																																																																																																																																																																																																											
15	ORB	\$ 460	\$ 865																																																																																																																																																																																																											
16	PVD Pol. Brass	\$ 460	\$ 865																																																																																																																																																																																																											
13	PVD Pol. Gold	\$ 625	\$ 1,085																																																																																																																																																																																																											
23	PVD Sat. Gold	\$ 625	\$ 1,085																																																																																																																																																																																																											



Order Example	A	B	C	D	E	F	To order, select an option in each of columns A - F and add Crating Charges.	
Washstand Item No.	360	P	S	C	54"	22		
Washstand Price	-	-	\$ 1,710	-	\$ 12,265	\$ 220	Total Price	\$ 14,195
	Single Oval Basin	Satin Etched Finish	Width of Counter					
		Peach Glass	Drain Collar		Sat. Nickel Metal Finish			
Crating Charges per Washstand: 24-41" width: \$560, 42-60" width: \$740. Freight additional, request quotation.								

## Countertop



Countertop in Starphire Satin Etched with Rectangular Leg and Towel Bar in Chrome.  
Shown with matching Freestanding ADA Large Round Basin.



Countertop in Bronze Polished glass.  
Shown with Freestanding Basin with Moderne Engraving.

Countertop To order, select an option in each of columns A–E. Include Item No. and Price. See Example at bottom of page.

Retail Price List

A Specify Model		B Glass Color		C Glass Finish			D Basin Hole(s)		E Specify Width			
		All Vitraform glass has color at the edge. None are devoid of color.		1 Frosted finish on bottom surface only. 2 Satin Etched finish on top and bottom surface. 3 White Lami, Mirror, Chalk or Pearl not available on Black. 4 White Lami or Chalk not available on Cobalt.			Included in Counter Price. For holes to accommodate customer's own sink please request price and drawing.		Priced in 6" increments. Drawings provided by Vitraform to exact dimension required.			
<b>With 1 Hole for Single Basin</b>		<b>Color Group 1</b>		<b>Item Finish Add</b>			<b>Item</b>		<b>Single Basin by Color Group</b>			
<b>Item</b>	<b>Description</b>	<b>Item</b>	<b>Color</b>	<b>Item</b>	<b>Finish</b>	<b>Add</b>	<b>Item</b>		<b>Item</b>	<b>Group 1</b>	<b>Group 2</b>	<b>Group 3</b>
<b>Rectangular Front</b>		C	Clear	P	Polished	\$ 00	N		18"	\$ 1,395	\$ 1,575	\$ 2,105
500	Single Round Basin	S	Starphire®	F	Frosted <sup>1</sup>			24"	\$ 1,625	\$ 1,765	\$ 2,290	
550	Single Oval Basin	Z	Bronze		18"-36" width	\$ 195		30"	\$ 1,825	\$ 1,995	\$ 2,750	
<b>Radius front</b>		G	Grey		37"-60" width	\$ 235		36"	\$ 2,015	\$ 2,230	\$ 3,100	
600	Single Round Basin	K	Black		61"-84" width	\$ 295		42"	\$ 2,215	\$ 2,460	\$ 3,455	
650	Single Oval Basin			O	White Lami <sup>3 4</sup>			48"	\$ 2,415	\$ 2,695	\$ 3,815	
<b>With 2 Holes for Double Basin</b>		<b>Color Group 2</b>			18"-36" width	\$ 195		54"	\$ 2,615	\$ 2,935	\$ 4,175	
<b>Rectangular Front</b>		P	Peach		37"-60" width	\$ 235		60"	\$ 2,815	\$ 3,170	\$ 4,525	
502	Double Round Basin	A	Azurlite®	S	Satin Etched <sup>2</sup>			66"	\$ 3,015	\$ 3,400	\$ 4,880	
552	Double Oval Basin	X	Solex®		18"-36" width	\$ 385		72"	\$ 3,215	\$ 3,635	\$ 5,240	
<b>Radius front</b>		<b>Color Group 3</b>			37"-60" width	\$ 470		78"	\$ 3,415	\$ 3,865	\$ 5,600	
602	Double Round Basin	T	Cobalt		61"-84" width	\$ 595		84"	\$ 3,610	\$ 4,105	\$ 5,955	
652	Double Oval Basin	B	Blue	M	Mirror <sup>3</sup>			<b>Double Basin by Color Group</b>				
<b>With 3 Holes for Triple Basin</b>		L	Cristal <sup>1</sup>		18"-36" width	\$ 580		<b>Item</b>	<b>Group 1</b>	<b>Group 2</b>	<b>Group 3</b>	
<b>Rectangular Front</b>		Q	Cristal Antiq <sup>1</sup>		37"-60" width	\$ 700		48"	\$ 2,820	\$ 3,100	\$ 4,285	
503	Triple Round Basin	1 For Cristal and Cristal Antiq contact factory for availability based on size.			61"-84" width	\$ 875		54"	\$ 3,015	\$ 3,335	\$ 4,640	
553	Triple Oval Basin	For White color specify Starphire glass in Color Group 1 with White Lami Finish in Column C.		H	Chalk <sup>3 4</sup>			60"	\$ 3,215	\$ 3,565	\$ 5,000	
<b>Radius front</b>					18"-36" width	\$ 580		66"	\$ 3,415	\$ 3,800	\$ 5,355	
603	Triple Round Basin				37"-60" width	\$ 710		72"	\$ 3,615	\$ 4,040	\$ 5,710	
653	Triple Oval Basin				61"-84" width	\$ 890		78"	\$ 3,815	\$ 4,275	\$ 6,065	
					18"-36" width	\$ 970		84"	\$ 4,015	\$ 4,505	\$ 6,425	
					37"-60" width	\$ 1,175		<b>Triple Basin by Color Group</b>				
					61"-84" width	\$ 1,470		<b>Item</b>	<b>Group 1</b>	<b>Group 2</b>	<b>Group 3</b>	
								72"	\$ 4,020	\$ 4,440	\$ 6,180	
								78"	\$ 4,220	\$ 4,670	\$ 6,535	
								84"	\$ 4,415	\$ 4,910	\$ 6,890	

Order Example	A	B	C	D	E	To order, select an option in each of columns A – E, and add Crating Charges.	
Countertop Item No.	600	Z	M	N	60"	Price	\$ 3,515
Countertop Price	-	-	\$ 700	-	\$2,815		
Single Round Basin      Mirror Finish      Width Bronze      No Overflow							
Crating Charges: 18-41" width: \$560, 42-60" width: \$740, 61-84" width: \$980. Up to 2 Countertops per crate. Freight additional, request quotation.							
For Mounting Hardware see pages 54-58							





Pedestal



Arabesque Pedestal in Black.

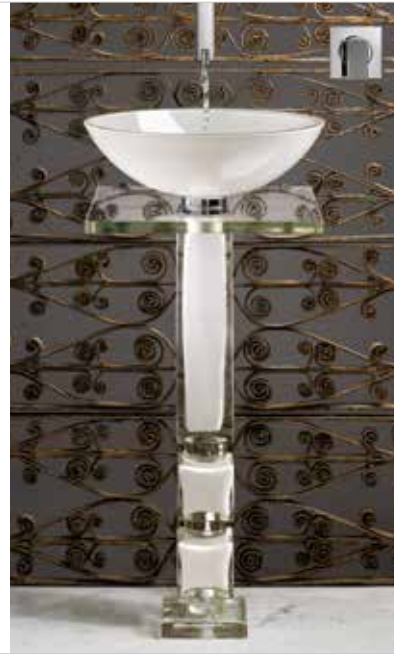

Cubetto Pedestal in White Polished.



Pullman Pedestal in Starphire Pearl.  
Shown with Round Mirror with Eolienne Engraving.

Arabesque and Battuto Pedestal To order, select an option in each of columns A and B. Include Item No. and Price. See Example at bottom of page.

Retail Price List

**A Select Pedestal Item**

Prices are for complete Pedestal\*

**Black glass with Arabesque Engraving**

Item	Description	Price
726KP36	Black Polished glass	\$ 20,120
M100KP22.XX.36	Matching Engraved Mirror	\$ 3,455

**Variation for Battuto Engraving**

Item	Description	Price
726LP30	Cristal Polished glass	\$ 22,115
M100LP22.XX.30	Matching Engraved Mirror	\$ 3,030

\* Includes Sink, Countertop, Pedestal Base, Drain Set and Surface Clips.  
 Dome drain and Euro Siphon included as standard. Contact factory to substitute a US P-trap or any other Vitraform drain with the Pedestal.  
 Arabesque and Battuto bases are mouth blown and will exhibit variations due to process.  
 Matching engraved mirrors as shown. Provide metal finish for clips where XX is shown. Request quote for additional sizes or variations. See Mirror page for other sizes and variations.

**B Metal Finish**

**Metal Finish upcharge for Pedestal**

Item	Description	Add
10	Pol. Chrome	\$ 00
12	Pol. Nickel	\$ 220
20	Sat. Chrome	\$ 220
22	Sat. Nickel	\$ 220
15	ORB	\$ 605
16	PVD Pol. Brass	\$ 605
13	PVD Pol. Gold	\$ 805
23	PVD Sat. Gold	\$ 805

**Metal Finish upcharge for Mirror**

Item	Description	Add
10	Pol. Chrome	\$ 00
12	Pol. Nickel	\$ 00
20	Sat. Chrome	\$ 00
22	Sat. Nickel	\$ 00
15	ORB	\$ 65
16	PVD Pol. Brass	\$ 65
13	PVD Pol. Gold	\$ 105
23	PVD Sat. Gold	\$ 105



Arabesque shown with matching Engraved Mirror

Order Example	A	B	To order, select an option in each of columns A and B and add Crating Charge.	
Pedestal Item No.	726LP30	22		
Pedestal Price	\$ 22,115	\$ 220	Total Price	\$ 22,335
Battuto Pedestal Cristal Polished Glass				
Sat. Nickel Hardware				
Crating Charges per pedestal \$740. Freight additional, request quotation.				

Cono Pedestal To order, select an option in each of columns A and B. Include Item No. and Price. See Example at bottom of page.

Retail Price List

A Select Pedestal Item			B Metal Finish		
Prices are for complete Pedestal*					
<b>Standard Cristal glass</b>					
Item	Description	Price	Item	Description	Add
724LP	Cristal Polished glass	\$ 13,045	10	Pol. Chrome	\$ 00
			12	Pol. Nickel	\$ 220
<b>Standard solid color glass</b>			20	Sat. Chrome	\$ 220
Item	Description	Price	22	Sat. Nickel	\$ 220
724WP	White Polished glass	\$ 15,045	15	ORB	\$ 605
724KP	Black Polished glass	\$ 14,050	16	PVD Pol. Brass	\$ 605
724TP	Cobalt Polished glass	\$ 15,040	13	PVD Pol. Gold	\$ 805
			23	PVD Sat. Gold	\$ 805
<b>Standard threaded color glass</b>					
Item	Description	Price			
724PP	Peach Polished, Threaded glass	\$ 16,420			
724AP	Azurlite Polished, Threaded glass	\$ 16,420			
724XP	Solex Polished, Threaded glass	\$ 16,420			
724ZP	Bronze Polished, Threaded glass	\$ 16,050			

\* Includes Sink, Countertop, Pedestal Base, Drain Set and Surface Clips.  
 Dome drain and Euro Siphon included as standard. Contact factory to substitute a US P-trap or any other Vitraform drain with the Pedestal.  
 Prices as shown in photos for each color. Variations in color for basin or counter by quotation.  
 Cono bases are mouth blown and will exhibit variations due to process.



Order Example	A	B	To order, select an option in each of columns A and B and add Crating Charge.	
Pedestal Item No.	724ZP	10	Total Price	\$ 16,050
Pedestal Price	\$ 16,050	\$ 00		
Bronze Polished Threaded Glass   Pol. Chrome Hardware				
Crating Charges per pedestal \$740. Freight additional, request quotation.				

Coppa Pedestal To order, select an option in each of columns A and B. Include Item No. and Price. See Example at bottom of page.

Retail Price List

A Select Pedestal Item			B Metal Finish		
Prices are for complete Pedestal*					
<b>Standard Cristal glass</b>					
Item	Description	Price	Item	Description	Add
722LP	Cristal Polished glass	\$ 13,045	10	Pol. Chrome	\$ 00
			12	Pol. Nickel	\$ 220
<b>Standard solid color glass</b>			20	Sat. Chrome	\$ 220
Item	Description	Price	22	Sat. Nickel	\$ 220
722WP	White Polished glass	\$ 15,045	15	ORB	\$ 605
722KP	Black Polished glass	\$ 14,050	16	PVD Pol. Brass	\$ 605
722TP	Cobalt Polished glass	\$ 15,040	13	PVD Pol. Gold	\$ 805
			23	PVD Sat. Gold	\$ 805
<b>Standard threaded color glass</b>					
Item	Description	Price			
722PP	Peach Polished, Threaded glass	\$ 16,420			
722AP	Azurlite Polished, Threaded glass	\$ 16,420			
722XP	Solex Polished, Threaded glass	\$ 16,420			
722ZP	Bronze Polished, Threaded glass	\$ 16,050			

\* Includes Sink, Countertop, Pedestal Base, Drain Set and Surface Clips.  
 Dome drain and Euro Siphon included as standard. Contact factory to substitute a US P-trap or any other Vitraform drain with the Pedestal.  
 Prices as shown in photos for each color. Variations in color for basin or counter by quotation.  
 Coppa bases are mouth blown and will exhibit variations due to process.



Order Example	A	B	To order, select an option in each of columns A and B and add Crating Charge.	
Pedestal Item No.	722KP	16	Total Price	\$ 14,655
Pedestal Price	\$ 14,050	\$ 605		
Black Polished Glass PVD Pol. Brass Hardware				
Crating Charges per pedestal \$740. Freight additional, request quotation.				

Cubetto Pedestal To order, select an option in each of columns A and B. Include Item No. and Price. See Example at bottom of page.

Retail Price List

A Select Pedestal Item			B Metal Finish		
Prices are for complete Pedestal*					
<b>Standard Cristal glass</b>					
Item	Description	Price	Item	Description	Add
725LP	Cristal Polished glass	\$ 12,800	10	Pol. Chrome	\$ 00
			12	Pol. Nickel	\$ 220
<b>Standard solid color glass</b>			20	Sat. Chrome	\$ 220
Item	Description	Price	22	Sat. Nickel	\$ 220
725WP	White Polished glass	\$ 14,800	15	ORB	\$ 605
725KP	Black Polished glass	\$ 14,230	16	PVD Pol. Brass	\$ 605
725TP	Cobalt Polished glass	\$ 14,800	13	PVD Pol. Gold	\$ 805
			23	PVD Sat. Gold	\$ 805
<p>* Includes Sink, Countertop, Pedestal Base, Drain Set and Surface Clips. Dome drain and Euro Siphon included as standard. Contact factory to substitute a US P-trap or any other Vitraform drain with the Pedestal.</p> <p>Prices as shown in photos for each color. Variations in color for basin or counter by quotation.</p> <p>Cubetto bases are mouth blown and will exhibit variations due to process.</p>					

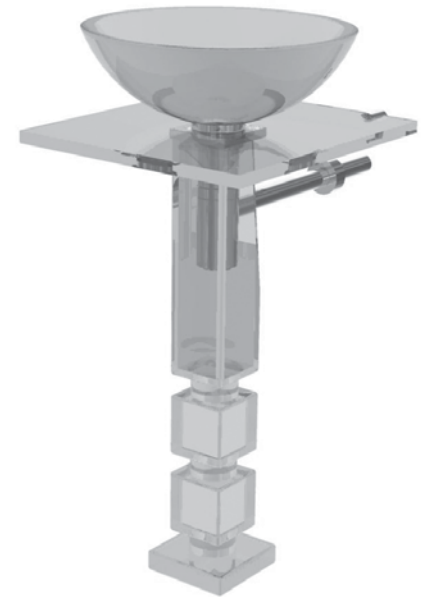

Order Example	A	B	To order, select an option in each of columns A and B and add Crating Charge.	
Pedestal Item No.	725KP	13		
Pedestal Price	\$ 14,230	\$ 805	Total Price	\$ 15,035
Black Polished Glass   Pol. Gold Hardware				
Crating Charges per pedestal \$740. Freight additional, request quotation.				

Glass Rod Pedestal To order, select an option in each of columns A and B. Include Item No. and Price. See Example at bottom of page.

Retail Price List

A Select Pedestal Item			B Metal Finish		
Prices are for complete Pedestal*					
<b>Standard Cristal glass</b>					
Item	Description	Price	Item	Description	Add
721LP	Cristal Polished glass	\$ 7,280	10	Pol. Chrome	\$ 00
			12	Pol. Nickel	\$ 220
			20	Sat. Chrome	\$ 220
			22	Sat. Nickel	\$ 220
			15	ORB	\$ 870
			16	PVD Pol. Brass	\$ 870
			13	PVD Pol. Gold	\$ 1,210
			23	PVD Sat. Gold	\$ 1,210
<p>* Includes Sink, 18" Countertop, 18" Towel Bar, Pedestal Base, Drain Set and Surface Clips.                      Dome drain and Euro Siphon included as standard. Contact factory to substitute a US P-trap or any other Vitraform drain with the Pedestal.                      Price for all Cristal components. Variations of basin and Countertop color by quotation.                      Variations of Countertop and Towel Bar size by quotation.                      Available without Towel Bar by quotation.</p>					



Order Example	A	B	To order, select an option in each of columns A and B and add Crating Charge.	
Pedestal Item No.	721LP	10		
Pedestal Price	\$ 7,280	\$ 00	Total Price	\$ 7,280
	Cristal Polished Glass	Pol. Chrome Hardware		
Crating Charges per pedestal \$740. Freight additional, request quotation.				



**Pullman Pedestal With Overflow** To order, select an option in each of columns A-E. Include Item No. and Price. See Example at bottom of page.

Retail Price List

A Select Pedestal Item			B Glass Color		C Glass Finish			D Overflow		E Metal Finish		
Prices are for complete Pedestal *			All Vitraform glass has color at the edge. None are devoid of color.					Overflow included.				
Color Group 1 Pricing			Color Group 1									
Item	Round	Price	Item	Color	Item	Finish	Add	Item		Item	Description	Add
723	Pullman Pedestal	\$ 4,030	C	Clear	P	Polished <sup>5</sup>	\$ 00	F	Overflow	10	Pol. Chrome	\$ 00
			S	Starphire®	O	White Lami <sup>3 4</sup>	\$ 150			12	Pol. Nickel	\$ 220
			Z	Bronze	S	Satin Etched <sup>2</sup>	\$ 530			20	Sat. Chrome	\$ 220
			G	Grey	M	Mirror <sup>3</sup>	\$ 1,150			22	Sat. Nickel	\$ 220
			K	Black	H	Chalk <sup>3 4</sup>	\$ 680			15	ORB	\$ 655
					E	Pearl <sup>3</sup>	\$ 1,680			16	PVD Pol. Brass	\$ 655
Color Group 2 Pricing			Color Group 2		<sup>2</sup> Satin Etched finish on inside and outside surface of glass components. <sup>3</sup> White Lami, Mirror, Chalk or Pearl not available on Black. <sup>4</sup> White Lami or Chalk not available on Cobalt. <sup>5</sup> Polished finish on glass colors other than Black or Cobalt is not recommended. Assembly by experienced glass installer using optically clear adhesive is necessary.							
Item	Round	Price	Item	Color								
723	Pullman Pedestal	\$ 4,575	P	Peach								
			A	Azurlite®								
			X	Solex®								
Color Group 3 Pricing			Color Group 3									
Item	Round	Price	Item	Color								
723	Pullman Pedestal	\$ 5,120	T	Cobalt								
			B	Blue								
* Includes Glass Panels, Sink, Drain Set, Overflow and Base Ring.  Dome Pop-up drain and Euro Siphon included as standard. Contact factory to substitute a US P-trap or any other Vitraform drain with the Pedestal.			For White color specify Starphire glass in Color Group 1 with White Lami Finish in Column C.									



Order Example	A	B	C	D	E	To order, select an option in each of columns A through E and add Crating Charges.	
Pedestal Item No.	723	P	S	F	22	Pedestal Price	\$ 4,575
		-	\$ 530	-	\$ 220	Total Price	\$ 5,325
	Pullman Pedestal		Satin Etched Peach Glass		Sat. Nickel Metal Finish Overflow		
Crating Charges per pedestal \$740. Freight additional, request quotation.							

**Pullman Pedestal Without Overflow** To order, select an option in each of columns A–E. Include Item No. and Price. See Example at bottom of page.

Retail Price List

A Select Pedestal Item			B Glass Color		C Glass Finish			D Drain Collar		E Metal Finish		
Prices are for complete Pedestal *			All Vitraform glass has color at the edge. None are devoid of color.					Drain Collar Included				
Color Group 1 Pricing			Color Group 1									
Item	Round	Price	Item	Color	Item	Finish	Add	Item		Item	Description	Add
723	Pullman Pedestal	\$ 4,030	C	Clear	P	Polished <sup>5</sup>	\$ 00	C	Drain Collar	10	Pol. Chrome	\$ 00
			S	Starphire®	O	White Lami <sup>3 4</sup>	\$ 150			12	Pol. Nickel	\$ 220
			Z	Bronze	S	Satin Etched <sup>2</sup>	\$ 530			20	Sat. Chrome	\$ 220
			G	Grey	M	Mirror <sup>3</sup>	\$ 1,150			22	Sat. Nickel	\$ 220
			K	Black	H	Chalk <sup>3 4</sup>	\$ 680			15	ORB	\$ 655
					E	Pearl <sup>3</sup>	\$ 1,680			16	PVD Pol. Brass	\$ 655
Color Group 2 Pricing			Color Group 2		<sup>2</sup> Satin Etched finish on inside and outside surface of glass components. <sup>3</sup> White Lami, Mirror, Chalk or Pearl not available on Black. <sup>4</sup> White Lami or Chalk not available on Cobalt. <sup>5</sup> Polished finish on glass colors other than Black or Cobalt is not recommended. Assembly by experienced glass installer using optically clear adhesive is necessary.							
Item	Round	Price	Item	Color								
723	Pullman Pedestal	\$ 4,575	P	Peach								
			A	Azurlite®								
			X	Solex®								
Color Group 3 Pricing			Color Group 3									
Item	Round	Price	Item	Color								
723	Pullman Pedestal	\$ 5,120	T	Cobalt								
			B	Blue								
* Includes Glass Panels, Sink, Drain Set, Drain Collar and Base Ring.  Dome drain and Euro Siphon included as standard. Contact factory to substitute a US P-trap or any other Vitraform drain with the Pedestal.			For White color specify Starphire glass in Color Group 1 with White Lami Finish in Column C.									



Order Example	A	B	C	D	E	To order, select an option in each of columns A through E and add Crating Charges.	
Pedestal Item No.	723	S	O	C	10	Pedestal Price	\$ 4,030
		-	\$ 150	-	\$ 00	Total Price	\$ 4,180
	Pullman Pedestal	White Lami	Pol. Chrome Metal Finish				
	Starphire Glass	Drain Collar					
Crating Charges per pedestal \$740. Freight additional, request quotation.							

## Vanity



GN2 Vanity in Walnut.  
Shown with Countersink with Rectangular Basins in Starphire Chalk.



GN Vanity in Teak.  
Shown with Countersink with Round Basin  
in Starphire White Lami.



Oval Vanity in Ebony.  
Shown with Freestanding Oval Basin in Cristal Polished  
glass with Palmier Engraving on Countertop in Black.

Vitraform GN2 Vanity with Drawers **NEW Product**

Retail Price List

**A Specify Model**

Includes 2 or 4 drawers depending on width.

**Vanity Model**

Item	Description
VF7	GN2 Vanity

**Notes:**  
Specify application of veneer to be vertical or horizontal.

LED lighting available for use with translucent glass finishes.

Touch-latch drawer mechanism standard. Drawer pulls optional or may be provided by other.

**B Specify Finish**

**Veneer Finishes**

Item	Description
AN	Anigre Veneer
EB	Ebony Veneer
SA	Sapele Veneer
SY	Sycamore Veneer
TK	Teak Veneer
WA	Walnut Veneer
TK	Wenge Veneer
WA	Zebra Veneer

**Lacquer Finishes**

Item	Description
XX	Matte Lacquer
XX	Gloss Lacquer

**C Specify Width**

Please contact factory for availability of specific veneers.  
48" Width can have either 2 or 4 drawers.

Width	Veneer Finishes								Lacquer Finishes	
	Anigre	Ebony	Sapele	Sycamore	Teak	Walnut	Wenge	Zebra	Matte	Gloss
24 in. with 2 Drawers	\$ 5,495	\$ 5,495	\$ 5,495	\$ 6,025	\$ 6,025	\$ 5,495	\$ 5,495	\$ 5,495	\$ 4,955	\$ 4,955
30 in. with 2 Drawers	\$ 5,710	\$ 5,710	\$ 5,710	\$ 6,240	\$ 6,240	\$ 5,710	\$ 5,710	\$ 5,710	\$ 5,150	\$ 5,150
36 in. with 2 Drawers	\$ 5,905	\$ 5,905	\$ 5,905	\$ 6,435	\$ 6,435	\$ 5,905	\$ 5,905	\$ 5,905	\$ 5,335	\$ 5,335
42 in. with 2 Drawers	\$ 6,155	\$ 6,155	\$ 6,155	\$ 6,685	\$ 6,685	\$ 6,155	\$ 6,155	\$ 6,155	\$ 5,600	\$ 5,600
48 in. with 2 Drawers	\$ 6,385	\$ 6,385	\$ 6,915	\$ 6,915	\$ 6,915	\$ 6,385	\$ 6,385	\$ 6,385	\$ 5,770	\$ 5,770
48 in. with 4 Drawers	\$ 8,465	\$ 8,465	\$ 8,465	\$ 8,995	\$ 8,995	\$ 8,465	\$ 8,465	\$ 8,465	\$ 7,325	\$ 7,325
54 in. with 4 Drawers	\$ 8,695	\$ 8,695	\$ 8,695	\$ 9,225	\$ 9,225	\$ 8,695	\$ 8,695	\$ 8,695	\$ 7,535	\$ 7,535
60 in. with 4 Drawers	\$ 8,910	\$ 8,910	\$ 8,910	\$ 9,440	\$ 9,440	\$ 8,910	\$ 8,910	\$ 8,910	\$ 7,745	\$ 7,745
72 in. with 4 Drawers	\$ 9,325	\$ 9,325	\$ 9,325	\$ 9,855	\$ 9,855	\$ 9,325	\$ 9,325	\$ 9,325	\$ 8,125	\$ 8,125
84 in. with 4 Drawers	\$ 9,735	\$ 9,735	\$ 9,735	\$ 10,265	\$ 10,265	\$ 9,735	\$ 9,735	\$ 9,735	\$ 8,540	\$ 8,540

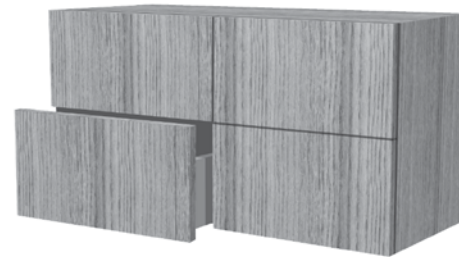

GN2 Vanity  
4 Drawers in Wood Veneer

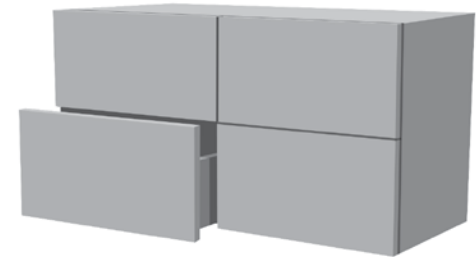

GN2 Vanity  
4 Drawers in Matte or Gloss Lacquer

Order Example	A	B	C	To order, select an option in each of columns A through C and add Crating Charges.	
Vanity Item No.	VF7	SA	42	Vanity Price	\$ 6,155
	-	-	\$ 6,155	Total Price	\$ 6,155
	GN2 Vanity	Sapele Veneer	Width		
Crating Charges: 24-41" width: \$560, 42-60" width: \$740, 61-84" width: \$980. Freight additional, request quotation.					

## Vitraform GN Vanity with Doors

Retail Price List

### A Specify Model

Number of doors based on width.

#### Vanity Model

Item	Description
VF4	GN Vanity

Notes:  
Specify application of veneer to be vertical or horizontal.

LED lighting available for use with translucent glass finishes.

Door pulls optional or may be provided by other.

### B Specify Finish

#### Veneer Finishes

Item	Description
AN	Anigre Veneer
EB	Ebony Veneer
SA	Sapele Veneer
SY	Sycamore Veneer
TK	Teak Veneer
WA	Walnut Veneer
TK	Wenge Veneer
WA	Zebra Veneer

### C Specify Width

Please contact factory for availability of specific veneers.

Width	Veneer Finishes							
	Anigre	Ebony	Sapele	Sycamore	Teak	Walnut	Wenge	Zebra
36 in.	\$ 2,995	\$ 2,995	\$ 2,995	\$ 3,525	\$ 3,525	\$ 2,995	\$ 2,995	\$ 2,995

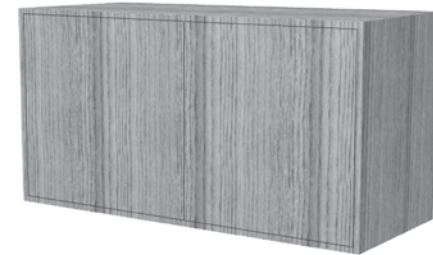

GN Vanity

Order Example	A	B	C	To order, select an option in each of columns A through C and add Crating Charges.	
Vanity Item No.	VF4	WA	36		
Vanity Price	-	-	\$ 2,995	Total Price	\$ 2,995
	GN Vanity	Walnut Veneer	Width		
Crating Charges: \$740. Freight additional, request quotation.					

# Vitraform Oval Vanity

Retail Price List

## A Specify Model

Specify application of veneer to be vertical or horizontal.

### Vanity Model

Item	Description
VF1	Oval Vanity for Countersinks (34 in. Height)
VF2	Oval Vanity for Freestanding Basin (30 in. Height)

**Notes:**  
LED lighting available for use with translucent glass finishes.  
Door pulls optional or may be provided by other.

## B Specify Finish

### Veneer Finishes

Item	Description
AN	Anigre Veneer
EB	Ebony Veneer
SA	Sapele Veneer
SY	Sycamore Veneer
TK	Teak Veneer
WA	Walnut Veneer
TK	Wenge Veneer
WA	Zebra Veneer

## C Specify Width

Please contact factory for availability of specific veneers.

Width	Veneer Finishes							
	Anigre	Ebony	Sapele	Sycamore	Teak	Walnut	Wenge	Zebra
30 in.	\$ 5,755	\$ 5,755	\$ 5,755	\$ 6,285	\$ 6,285	\$ 5,755	\$ 5,755	\$ 5,755



VF1 Oval Vanity for Countersinks



VF2 Oval Vanity for Freestanding Basins

Order Example	A	B	C	To order, select an option in each of columns A through C and add Crating Charges.	
Vanity Item No.	VF1	WA	30		
Vanity Price	-	-	\$ 5,755	Total Price	\$ 5,755
Oval Vanity for Countersinks		Walnut Veneer		Width	
Crating Charges: \$740. Freight additional, request quotation.					



## Vitraform T Vanity

Retail Price List

### A Specify Model

Specify application of veneer to be vertical or horizontal.

#### Vanity Model

Item	Description
VF3	T Vanity

**Notes:**  
LED lighting available for use with translucent glass finishes.

Touch-latch door mechanism standard.  
Door pulls optional or may be provided by other.

### B Specify Finish

#### Veneer Finishes

Item	Description
AN	Anigre Veneer
EB	Ebony Veneer
SA	Sapele Veneer
SY	Sycamore Veneer
TK	Teak Veneer
WA	Walnut Veneer
TK	Wenge Veneer
WA	Zebra Veneer

### C Specify Width

Please contact factory for availability of specific veneers.

Width	Veneer Finishes							
	Anigre	Ebony	Sapele	Sycamore	Teak	Walnut	Wenge	Zebra
25 in.	\$ 3,410	\$ 3,410	\$ 3,410	\$ 3,940	\$ 3,940	\$ 3,410	\$ 3,410	\$ 3,410
36 in.	\$ 3,410	\$ 3,410	\$ 3,410	\$ 3,940	\$ 3,940	\$ 3,410	\$ 3,410	\$ 3,410



T Vanity 25 in. width







T Vanity 36 In. width

Order Example	A	B	C	To order, select an option in each of columns A through C and add Crating Charges.	
Vanity Item No.	VF3	WA	25		
Vanity Price	-	-	\$ 3,410	Total Price	\$ 3,410
	T Vanity	Walnut Veneer	Width		
Crating Charges: \$740. Freight additional, request quotation.					







Wall Mirrors To order, select an option in each of columns A-E. Include Item No. and Price. See Example at bottom of page.

Retail Price List

A Select Wall Mirror			B Glass Color		C Glass Finish			D Mirror Size				E Metal Finish			F Decorative Finish		
Prices are the same for all Vitraform glass colors.			All Vitraform glass has color at the edge. None are devoid of color. Contact factory for coordination of colors and finishes.		1 Frosted finish on back surface only. 2 Satin etched on front and back surface. 3 Translucent White, Mirror, Chalk or Pearl finish is not available on Black. 4 Translucent White or Chalk finish not available on Cobalt.			Custom sizes available by quotation.							Engraved, Perla and Gilded finishes are available on Vitraform Mirrors. Prices are based on mirror size. For Gilded Finish contact factory for quotation. See Order Example below including Engraved Finish.		
Mirror Style			Glass Colors														
Item	Description	Price	Item	Color	Item	Finish	Add	Item	Description	Size	Shape	Item	Description	Add	Item	Description	Add
M100	Round Wall Mirror	\$ 1,030	C	Clear	P	Polished	\$ 00	24	Round	24" Dia.		10	Pol. Chrome	\$ 00		Engraving & Perla	
M150	Oval Wall Mirror	\$ 1,030	S	Starphire®	F	Frosted <sup>1</sup>	\$ 195					12	Pol. Nickel	\$ 00	00	None	\$ 00
M175	Square Wall Mirror	\$ 1,210	Z	Bronze	O	Translucent White <sup>3,4</sup>	\$ 135	2228	Oval <sup>1</sup>	22w" x 28h"		20	Sat. Chrome	\$ 00	11	Empire	\$ 1,920
M170	Rectangular Wall Mirror	\$ 1,450	G	Grey	S	Satin Etched <sup>2</sup>	\$ 135					22	Sat. Nickel	\$ 00	12	Floral	\$ 1,595
Mirror includes mounting hardware.			K	Black	M	Mirror Finish <sup>3</sup>	\$ 580	2424	Square	24" x 24"		15	ORB	\$ 65	13	Victorian	\$ 1,920
			P	Peach	H	Chalk <sup>3,4</sup>	\$ 265					16	PVD Pol. Brass	\$ 65	14	Deco	\$ 1,920
			A	Azurlite®	E	Pearl <sup>3</sup>	\$ 715	3624	Rectangular <sup>1</sup>	36w" x 24h"		13	PVD Pol. Gold	\$ 105	15	Tulip	\$ 1,920
			X	Solex®	1 Please specify orientation of mirror for Rectangle and Oval shapes.												
			T	Cobalt													
			B	Blue													
			L	Cristal													
			Q	Cristal Antiq													
			For White color specify Starphire glass in Color Group 1 with White Lami Finish in Column C.														
																	
Order Example																	
Mirror Item No.	A	B	C	D	E	F	Engraving Finish Upcharge (Mirror Finish)	To order, select an option in each of columns A through E and Crating Charges.									
Mirror Price	\$ 1,030	-	\$ 580	-	\$ 00	\$ 2,345	\$ 255	Total Price	\$ 4,210								
Round Wall Mirror		Mirror Finish		Pol. Chrome Metal Finish													
Starphire		24 in. diameter		Eolienne Engraving													
Crating \$480 Shipped via Truck Line only. Request quote for multiple items on one order. Request Quote for freight charges.																	
Engraving Finish Upcharge																	
Add upcharge for glass finish on engravings only, not Perla. Does not affect item number.																	
Glass Finish																	Add
Mirror Finish (Column C)																	\$ 255

**Drains** All Drain Sets include either US P-Trap or Euro-Siphon. To order, select Item Number and Metal Finish Code to replace "XX". See Example at bottom of page.

Retail Price List

		<b>Finish Group 1</b>	<b>Finish Group 2</b>	<b>Finish Group 3</b>	<b>Finish Group 4</b>		
		10 Pol. Chrome	12 Pol. Nickel 20 Sat. Chrome 22 Sat. Nickel	15 ORB 16 PVD Pol. Brass	13 PVD Pol. Gold 23 PVD Sat. Gold		
<b>Grid Strainer Set</b>						US P-Trap	Euro-Siphon
Item	Description						
810.XX	with Overflow with US P-Trap	\$ 330	\$ 575	\$ 750	\$ 820		
811.XX	without Overflow with US P-Trap	\$ 330	\$ 575	\$ 750	\$ 820		
810.XX.S	with Overflow with Euro-Siphon	\$ 455	\$ 670	\$ 855	\$ 920		
811.XX.S	without Overflow with Euro-Siphon	\$ 455	\$ 670	\$ 855	\$ 920		
<b>Dome Drain Open Set</b>						US P-Trap	Euro-Siphon
Item	Description						
860.XX	with Overflow with US P-Trap	\$ 330	\$ 575	\$ 750	\$ 820		
861.XX	without Overflow with US P-Trap	\$ 330	\$ 575	\$ 750	\$ 820		
860.XX.S	with Overflow with Euro-Siphon	\$ 455	\$ 670	\$ 855	\$ 920		
861.XX.S	without Overflow with Euro-Siphon	\$ 455	\$ 670	\$ 855	\$ 920		
<b>Dome Drain Pop-up Set</b>						US P-Trap	Euro-Siphon
Item	Description						
862.XX	with Overflow with US P-Trap	\$ 330	\$ 575	\$ 750	\$ 820		
863.XX	without Overflow with US P-Trap	\$ 330	\$ 575	\$ 750	\$ 820		
862.XX.S	with Overflow with Euro-Siphon	\$ 455	\$ 670	\$ 855	\$ 920		
863.XX.S	without Overflow with Euro-Siphon	\$ 455	\$ 670	\$ 855	\$ 920		

Order Example	Item No.	Finish Code	Price ea.	Qty	Total
Drain Item No.	860	22.S	\$ 670	1	\$ 670
Dome Drain Pop-up Set with Overflow with Euro-Siphon Sat. Nickel Metal Finish					



**Hardware** To order, select Item Number and Metal Finish Code to replace "XX". See Example at bottom of page.

Retail Price List

Available only for use with Vitraform Products.

Individual components to be combined for complete installation with Vitraform CounterSinks and CounterTops.

See also pages 56-58 for Console legs to be used for front support.

Finish Group 1	Finish Group 2	Finish Group 3	Finish Group 4
10 Pol. Chrome	12 Pol. Nickel 20 Sat. Chrome 22 Sat. Nickel	15 ORB 16 PVD Pol. Brass	13 PVD Pol. Gold 23 PVD Sat. Gold

Cabinet Pull					
Item	Description				
VCP.XX	Each	\$ 25	\$ 25	\$ 35	\$ 40



Side Wall Mount Trim and Rough					
Item	Description				
741.XX	Each	\$ 135	\$ 135	\$ 150	\$ 175



Surface Clip					
Item	Description				
760.XX	Each	\$ 120	\$ 120	\$ 145	\$ 170



Flush Clip					
Item	Description				
761.XX	Each	\$ 165	\$ 165	\$ 175	\$ 195



U-Channel					
Item	Description				
751.54	U-Channel (Aluminum)	\$ 40	per linear foot. priced in one foot increments, rounded up to the nearest foot.		



Six Inch Tapered Leg					
Item	Description				
780.XX	Each	\$ 320	\$ 320	\$ 350	\$ 365



Counter Support Leg					
Item	Description				
790.XX	Two Part (Round) Each	\$ 210	\$ 210	\$ 290	\$ 350



Order Example	Item No.	Finish Code	Price ea.	Qty	Total
Hardware Item	761	15	\$ 175	1	\$ 175
 Flush Clip    Oil Rubbed Bronze Metal Finish					

**Hardware** To order, select Item Number and Metal Finish Code to replace "XX". See Example at bottom of page.

Retail Price List

Hardware only. Does not include glass.  Available only for use with Vitraform Products.  See page 55 for choice of mounting hardware at back wall to coordinate with this leg system.	<b>Finish Group 1</b>	<b>Finish Group 2</b>	<b>Finish Group 3</b>	<b>Finish Group 4</b>	Hardware only. Set does not include glass.
	10 Pol. Chrome	12 Pol. Nickel 20 Sat. Chrome 22 Sat. Nickel	15 ORB 16 PVD Pol. Brass	13 PVD Pol. Gold 23 PVD Sat. Gold	

**Round Console Legs without Shelf (Tubular metal)**

Item	Description				
775.XX	Console Legs (Pair)	\$ 830	\$ 830	\$ 920	\$ 1,150



**Round Console Legs with Towel Bar**

Item	Description				
776.XX	Console Legs (Pair) with Straight Towel Bar in front	\$ 1,250	\$ 1,250	\$ 1,360	\$ 1,595
777.XX	Console Legs (Pair) with Curved Towel Bar in front	\$ 1,305	\$ 1,305	\$ 1,435	\$ 1,705



**Round Console Legs with Shelf**

Item	Description				
775.XX.S	Console Legs (Pair) No Towel Bar	\$ 1,095	\$ 1,095	\$ 1,185	\$ 1,410
776.XX.S	Console Legs (Pair) with Straight Towel Bar	\$ 1,515	\$ 1,515	\$ 1,625	\$ 1,865
777.XX.S	Console Legs (Pair) with Curved Towel Bar	\$ 1,575	\$ 1,575	\$ 1,705	\$ 1,970



Order Example	Item No.	Finish Code	Price ea.	Qty	Total
Hardware Item	777	22	\$ 1,305	1	\$ 1,305
Round Console Legs (Pair) with cuved Towel Bar Sat. Nickel Metal Finish					



**Hardware** To order, select Item Number and Metal Finish Code to replace "XX". See Example at bottom of page.

Retail Price List

Hardware only. Does not include glass.  Available only for use with Vitraform Products.  See page 55 for choice of mounting hardware at back wall to coordinate with this leg system.	<b>Finish Group 1</b>	<b>Finish Group 2</b>	<b>Finish Group 3</b>	<b>Finish Group 4</b>	Hardware only. Set does not include glass.
	10 Pol. Chrome	12 Pol. Nickel 20 Sat. Chrome 22 Sat. Nickel	15 ORB 16 PVD Pol. Brass	13 PVD Pol. Gold 23 PVD Sat. Gold	

**Rectangular Console Legs without Shelf**

Item	Description				
785.XX	Console Legs (Pair)	\$ 1,400	\$ 1,400	\$ 1,545	\$ 1,825



**Rectangular Console Legs with 1 Towel Bar**

Item	Description				
786.XX	Console Legs (Pair) with Straight Towel Bar in front	\$ 2,035	\$ 2,035	\$ 2,135	\$ 2,380



**Rectangular Console Legs with up to 3 Towel Bars**

Item	Description				
787.XX	Console Legs (Pair) w Straight Towel Bar Front & 1 Side	\$ 2,515	\$ 2,515	\$ 2,640	\$ 2,890
788.XX	Console Legs (Pair) Straight Towel Bar Front & 2 Sides	\$ 2,995	\$ 2,995	\$ 3,130	\$ 3,395



Order Example	Item No.	Finish Code	Price ea.	Qty	Total
Hardware Item	786	16	\$ 2,135	1	\$ 2,135
Rectangular Console Legs (Pair) with Straight Towel Bar in Front PVD Pol. Brass Metal Finish					

**Hardware** To order, select Item Number and Metal Finish Code to replace "XX". See Example at bottom of page.

Retail Price List

Hardware only. Does not include glass.  Available only for use with Vitraform Products.  See page 55 for choice of mounting hardware at back wall to coordinate with this leg system.	<b>Finish Group 1</b>	<b>Finish Group 2</b>	<b>Finish Group 3</b>	<b>Finish Group 4</b>
	10 Pol. Chrome	12 Pol. Nickel 20 Sat. Chrome 22 Sat. Nickel	15 ORB 16 PVD Pol. Brass	13 PVD Pol. Gold 23 PVD Sat. Gold

Hardware only. Set does not include glass.

**Cristal Glass Rod Console Legs**

Item	Description				
771.LP.XX	Polished Glass (Pair) for glass counters	\$ 1,065	\$ 1,065	\$ 1,265	\$ 1,465
771.LF.XX	Frosted Glass (Pair) for glass counters	\$ 1,200	\$ 1,200	\$ 1,400	\$ 1,595
771.LP.XX.ST	Polished Glass (Pair) for stone counters	\$ 1,065	\$ 1,065	\$ 1,265	\$ 1,465
771.LF.XX.ST	Frosted Glass (Pair) for stone counters	\$ 1,190	\$ 1,190	\$ 1,400	\$ 1,595



**Cristal Glass Rod Towel Bar**

Item	Description				
772.LP.XX	Polished Glass with Two Supports	\$ 520	\$ 520	\$ 655	\$ 785
772.LF.XX	Frosted Glass with Two Supports	\$ 585	\$ 585	\$ 720	\$ 855



Order Example	Item No.	Finish Code	Price ea.	Qty	Total
Hardware Item	771.LF	15	\$ 1,400	1	\$ 1,400
Cristal Frosted Glass Rod Console Legs      ORB Metal Finish					

Ordering information

Retail Price List

**Warranty**

Vitraform warrants for a period of five years that the product will be free from defects in material and Workmanship in accordance with Glass Industry Standards, when installed in Lavatory applications. This Warranty is expressly made in lieu of any and all other warranties, expressed or implied, which are hereby expressly disclaimed. This Warranty does not cover damage caused to the goods during shipment, or by improper installation techniques, modifications, physical force or other abuse and does not cover any related labor charges, removal and reinstallation expense, freight or postage. Vitraform shall only be responsible for repairing or replacing any part or parts that do not comply with this Warranty, as determined by Vitraform. Vitraform's total liability under this Warranty will not exceed the purchase price for the goods and will not include consequential damages.

**Warranty Claims**

Any warranty claims must be made in writing to Vitraform, 4201 E 48th Ave, Denver, CO 80216. Please include original Vitraform Sales Order or Invoice number, date of purchase, item(s) description and description of claim.

**Shortage**

Claims for shortages must be made in writing to Vitraform within 5 days of receipt of shipment.

**Freight Claims**

Claims for freight damage must be made with the carrier. Note visible damage to cartons or crates upon receipt and inspect shipment. Request inspection by the carrier within the time limit allowed by the carrier.

**Returns**

All return goods must be accompanied by a Return Goods Authorization form provided by and at the discretion of Vitraform within 6 months of receipt of product. All products accepted for return will bear a 25% restock fee. Due to the broad range of options and potentially custom nature of some items, Vitraform may not accept return of products in certain colors, finishes or engraved designs. Please order carefully. RGA requests must be submitted in writing by the authorized Vitraform Dealer that purchased the item. Provide original purchase order number and date, description of item(s) to be returned and reason for return. Items that have been installed will only be accepted for return if warranty is involved. If Vitraform accepts the return for evaluation, a copy of a written RGA form will be provided to include with the returned item. The item must be returned within 30 days of receipt of written RGA form. Items accepted for return must be packed in original box with original packing, insured and shipped prepaid. New Vitraform boxes may be ordered for safe return if original box is unavailable. A \$15.00 box charge and outbound freight will be charged. If damage occurs during shipping, due to improper packing, no credit will be issued. Vitraform will inspect the condition of the product upon receipt and evaluate the amount of credit or repair charges due, if any.

**Prices**

Vitraform reserves the right to change prices without notice at any time before confirmation of your order. Prices shown are Retail prices with the exception of Freight and Crating, which are Net. Additional charges exist and are referred to as: shipping, delivery, insurance, export documentation, handling and storage. All prices shown are F.O.B. Denver, CO.

**Shipping and Crating**

Vitraform Standard Basins, Freestanding Basins and Hardware are packed in boxes and may be shipped via UPS, Federal Express, or Common Carrier. There are no box charges for these items. Countersinks, Countertops, Vanities, Pedstals and Mirrors are crated to be shipped Common Carrier. Crating charges are listed on the Price List page for those items.

**Freight Charges**

All freight charges are Net. Retail prices for products do not include freight charges. Please refer to the table below to estimate freight for Vitraform products. Most carriers have web sites that allow you to use box size and weight shown below to quote freight. Remember to add insurance. **The Tables below show examples for estimating freight costs for Vitraform Products.**

Item(s)	Box Size (in inches) Depth x Width x Height	Domestic Dimensional Weight	International Dimensional Weight	Actual Weight
<b>STANDARD BASINS</b>				
Undermount & Drop-in Round	20 x 22 x 12"	32 lbs.	38 lbs.	25 lbs.
Undermount & Drop-in Oval	26 x 22 x 12"	32 lbs.	50 lbs.	28 lbs.
Undermount & Drop-in Rectangular	30 x 25 x 18"	82 lbs.	98 lbs.	60 lbs.
<b>FREESTANDING &amp; RIMLESS BASINS</b>				
Small Round Item 200, 203	21 x 18 x 10"	23 lbs.	28 lbs.	20 lbs.
Large Round Item 210, 214, 213	20 x 22 x 12"	32 lbs.	38 lbs.	30 lbs.
Small Oval Freestanding Item 250, 253	23 x 18 x 10"	25 lbs.	30 lbs.	20 lbs.
Large Oval Freestanding Item 260, 264, 263	26 x 22 x 12"	42 lbs.	50 lbs.	30 lbs.
Large Round Freestanding with Pencil Edge	20 x 22 x 12"	32 lbs.	38 lbs.	25 lbs.
Rectangular Freestanding Basins Item 235, 240	30 x 25 x 18"	82 lbs.	98 lbs.	60 lbs.
<b>COUNTERSINKS &amp; COUNTERTOPS</b>				
20" to 42" wide		175 lbs.		
43" to 60" wide		225 lbs.		
61" to 84" wide		310 lbs.		
Information above shows a range of sizes for estimating freight charges for Countersinks and Countertops. Actual weight, crate sizes and prices will vary according to exact dimensions of counter and hardware included. Weights above are for crates containing one Countersink or Countertop per crate. Crates may contain a maximum of two Countersinks or Countertops. Request quotation for multiple Countersinks or Countertops. These weights are only for rough estimating. Please request exact freight quote if needed.				
<b>VANITIES</b>				
VF1 Vanity with Countersink	26.5 x 33.5 x 35.75"	350 lbs.		
VF2 Vanity with Countertop	26.5 x 33.5 x 31.75"	245 lbs.		
VF3 Vanity	24.5 x 40.5 x 34.75"	130 lbs.		
VF4 Vanity (counter not included)	24.5 x 40.5 x 27.75"	270 lbs.		
Information above shows sizes and weights for standard Vitraform Vanities without Vitraform glass products, which may be crated separately. For custom sizes, request quotation. Estimate Vitraform Wash Stand based on table above for Countersinks. Actual weight, crate sizes and prices will vary according to exact dimensions of vanity and hardware included. These weights are only for rough estimating. Please request exact freight quote if needed.				
<b>PEDESTALS</b>				
722, 724, 725, 726	37 x 23 x 38"	170 lbs.		
Pullman Pedstal 723	39 x 21 x 30"	170 lbs.		
Glass Rod Pedestal 721	30 x 24 x 30"	107 lbs.		

